

IBM Storwize V7000
Version 6.3.0

CIM Agent Developer's Guide



Note

Before using this information and the product it supports, read the information in "Notices" on page 67.

This edition applies to the IBM Storwize V7000, Version 6.3.0, and to all subsequent releases and modifications until otherwise indicated in new editions.

This edition replaces GC27-2292-01.

© **Copyright IBM Corporation 2010, 2011.**

US Government Users Restricted Rights – Use, duplication or disclosure restricted by GSA ADP Schedule Contract with IBM Corp.

Contents

Figures	v
--------------------------	----------

Tables	vii
-------------------------	------------

About this guide **ix**

Who should use this guide	ix
Summary of changes	ix
Summary of changes for GC27-2292-02 Storwize V7000 CIM Agent Developer's Guide	ix
Summary of changes for GC27-2292-01 Storwize V7000 CIM Agent Developer's Guide	x
Emphasis	x
Storwize V7000 library and related publications	x
How to order IBM publications	xiii
Sending your comments	xiii

Chapter 1. Introduction to CIM agent . . . **1**

Storage Management Initiative Specification	1
CIM agent	2
CIM agent concepts	2
CIM agent components	3
CIM agent for Storwize V7000	3
Examples of how the CIM agent works	3
Storwize V7000 CIMOM programming	6
How Storwize V7000 concepts map to CIM concepts	7
Functional diagrams of the Common Information Model agent	9
Access point subprofile	9
Block server performance subprofile	9
Block services profile	11
RAID support for block services	13
Clustered system subprofile	13
Copy Services	14
Disk drive lite profile	15
Disk-drive sparing	16
Enclosure profile	18
Extent composition subprofile	18
FC port profile	19
Interop profile	20
iSCSI relationships	21
Job control profile	23
Location subprofile	23
Masking and mapping profile	24
Multiple computer system profile	25
Object manager adapter profile	26
Physical package	27
Server profile	27
Software profile	28
Storage volume mirroring	29

Chapter 2. Performing storage configuration tasks **31**

Creating a new storage pool.	31
Modifying a storage pool.	32
Creating a new storage volume.	32
Creating a RAID array.	33

Chapter 3. Establishing Copy Services relationships **35**

Copy Services	35
Creating a new FlashCopy relationship between storage volumes	35
Creating a FlashCopy relationship for a synchronized set.	36
Creating a synchronous copy relationship between volumes in the same clustered system	37
Creating a synchronous copy relationship between volumes in different clustered systems	38
Sample code to create and start a FlashCopy mapping	39

Chapter 4. CIM agent network considerations **45**

RemoteServiceAccessPoint instance	45
---	----

Chapter 5. Maintenance and diagnostic tasks **47**

Getting a list of classes	47
Getting a list of UnitTypes	47
Getting the number of currently installed units	47
Using the indication service	48
Getting performance statistics	48
Collecting CIM log files	49

Chapter 6. CIM agent classes, methods, and SMI-S profiles supported **51**

Chapter 7. Return codes **53**

Appendix. Accessibility **65**

Notices **67**

Trademarks	69
----------------------	----

Index **71**

Figures

1. A typical CIM agent at work 4
2. CIMOM on the clustered system 6
3. Java program for connecting to a Storwize V7000 CIMOM. 7
4. High-level overview of the access point subprofile of the CIM agent 9
5. Block server performance subprofile 10
6. High-level overview of block services. 12
7. RAID support for block services 13
8. Class diagram of clustered-system instance 14
9. Class diagram of copy services instances 15
10. Overview of the Unified Modeling Language elements of the disk drive lite profile 16
11. Disk-drive sparing CIM structure 17
12. IsSpare association 17
13. Association during failure. 18
14. Elements of the enclosure profile 18
15. Extent composition subprofile 19
16. Class diagram of FC port instances 20
17. Class diagram of interop instances 21
18. Overview of iSCSI-specific aspects of a target device 22
19. Class diagram of job control instances. 23
20. Overview of the relationship between location and physical package 24
21. Class diagram of masking and mapping instances 25
22. Class diagram of multiple computer system instances 26
23. Overview of the Unified Modeling Language elements of the object manager adapter profile. 27
24. High-level overview of the physical package of the CIM agent for the Storwize V7000. 27
25. High-level overview of the server profile of the CIM agent for the Storwize V7000. 28
26. Class diagram of software instances 28
27. Classes and associations in mirroring storage volumes. 29

Tables

1. Storwize V7000 library	xi	5. SMI-S profiles and subprofiles supported by CIM	51
2. Other IBM publications	xii	6. Common Information Model return codes	53
3. IBM documentation and related websites	xiii		
4. Relating Storwize V7000 concepts to CIM concepts	7		

About this guide

This publication introduces the Common Information Model (CIM) agent for the IBM® Storwize® V7000 and Storwize V7000 Unified.

This section describes:

- Content and intended audience of this book
- Typefaces that are used to show emphasis
- Information that is related to this book
- Websites that provide information about the Storwize V7000 or related products or technologies
- How to order IBM publications
- How to send in your feedback on this book

Who should use this guide

This reference book is for application programmers who are developing with the Common Information Model.

This reference book is for CIM-based application programmers who want to perform the following tasks:

- Understand the CIM agent for the Storwize V7000
- Discover and connect to the CIM agent service
- Retrieve and extract the CIM agent object classes, attributes, and methods
- Create new object instances for basic storage configuration, logical unit number (LUN) masking, and Copy Services on the Storwize V7000

Summary of changes

This document contains terminology, maintenance, and editorial changes.

Technical changes or additions to the text and illustrations are indicated by a vertical line to the left of the change. This summary of changes describes new functions that have been added to this release.

Summary of changes for GC27-2292-02 Storwize V7000 CIM Agent Developer's Guide

The summary of changes provides a list of new, modified, and changed information since the last version of the guide.

New information

This topic describes the changes to this guide since the previous edition of this guide, GC27-2292-01. The following section summarizes the changes that have since been implemented from the previous version.

This version includes the following general new information:

- The FCPort profile has been updated.

Summary of changes for GC27-2292-01 Storwize V7000 CIM Agent Developer's Guide

The summary of changes provides a list of new, modified, and changed information since the last version of the guide.

New information

This topic describes the changes to this guide since the previous edition of the *IBM System Storage SAN Volume Controller CIM Agent Developer's Guide, GC27-2292-00*. The following section summarizes the changes that have since been implemented from the previous version.

This version includes the following general new information:

- An interop profile has been added.
- The term "cluster" has been replaced by the term "system" or "clustered system" in most instances.

Emphasis

Different typefaces are used in this guide to show emphasis.

The following typefaces are used to show emphasis:

Boldface	Text in boldface represents menu items.
Bold monospace	Text in bold monospace represents command names.
<i>Italics</i>	Text in <i>italics</i> is used to emphasize a word. In command syntax, it is used for variables for which you supply actual values, such as a default directory or the name of a system.
Monospace	Text in monospace identifies the data or commands that you type, samples of command output, examples of program code or messages from the system, or names of command flags, parameters, arguments, and name-value pairs.

Storwize V7000 library and related publications

Product manuals, other publications, and websites contain information that relates to Storwize V7000.

Storwize V7000 Information Center

The IBM Storwize V7000 Information Center contains all of the information that is required to install, configure, and manage the Storwize V7000. The information center is updated between Storwize V7000 product releases to provide the most current documentation. The information center is available at the following website:

publib.boulder.ibm.com/infocenter/storwize/ic/index.jsp

Storwize V7000 library

Unless otherwise noted, the publications in the Storwize V7000 library are available in Adobe portable document format (PDF) from the following website:

Support for Storwize V7000 website at www.ibm.com/storage/support/storwize/v7000

Each of the PDF publications in Table 1 is available in this information center by clicking the number in the “Order number” column:

Table 1. Storwize V7000 library

Title	Description	Order number
<i>IBM Storwize V7000 Quick Installation Guide</i>	This guide provides instructions for unpacking your shipping order and installing your system. The first of three chapters describes verifying your order, becoming familiar with the hardware components, and meeting environmental requirements. The second chapter describes installing the hardware and attaching data cables and power cords. The last chapter describes accessing the management GUI to initially configure your system.	GC27-2290
<i>IBM Storwize V7000 Troubleshooting, Recovery, and Maintenance Guide</i>	This guide describes how to service, maintain, and troubleshoot the Storwize V7000 system.	GC27-2291
<i>IBM Storwize V7000 CIM Agent Developer's Guide</i>	This guide describes the concepts of the Common Information Model (CIM) environment. Procedures describe such tasks as using the CIM agent object class instances to complete basic storage configuration tasks, establishing new Copy Services relationships, and performing CIM agent maintenance and diagnostic tasks.	GC27-2292

Table 1. Storwize V7000 library (continued)

Title	Description	Order number
<i>IBM Storwize V7000 Safety Notices</i>	This guide contains translated caution and danger statements. Each caution and danger statement in the Storwize V7000 documentation has a number that you can use to locate the corresponding statement in your language in the <i>IBM Storwize V7000 Safety Notices</i> document.	GC27-3924
<i>IBM Storwize V7000 Read First Flyer</i>	This document introduces the major components of the Storwize V7000 system and describes how to get started with the <i>IBM Storwize V7000 Quick Installation Guide</i> .	GC27-2293
<i>IBM System Storage SAN Volume Controller and IBM Storwize V7000 Command-Line Interface User's Guide</i>	This guide describes the commands that you can use from the Storwize V7000 command-line interface (CLI).	GC27-2287
<i>IBM Statement of Limited Warranty (2145 and 2076)</i>	This multilingual document provides information about the IBM warranty for machine types 2145 and 2076.	Part number: 85Y5978
<i>IBM License Agreement for Machine Code</i>	This multilingual guide contains the License Agreement for Machine Code for the Storwize V7000 product.	Z125-5468

Other IBM publications

Table 2 lists IBM publications that contain information related to the Storwize V7000.

Table 2. Other IBM publications

Title	Description	Order number
<i>IBM Storage Management Pack for Microsoft System Center Operations Manager User Guide</i>	This guide describes how to install, configure, and use the IBM Storage Management Pack for Microsoft System Center Operations Manager (SCOM).	GC27-3909 publibfp.dhe.ibm.com/epubs/pdf/c2739092.pdf
<i>IBM Storage Management Console for VMware vCenter, version 2.6.0, Installation Guide</i>	This publication provides installation, configuration, and usage instructions for the IBM Storage Management Console for VMware vCenter.	GA32-0929 publibfp.dhe.ibm.com/epubs/pdf/a3209295.pdf

IBM documentation and related websites

Table 3 lists websites that provide publications and other information about the Storwize V7000 or related products or technologies.

Table 3. IBM documentation and related websites

Website	Address
Support for Storwize V7000 (2076)	Support for Storwize V7000 website at www.ibm.com/storage/support/storwize/v7000
Support for IBM System Storage [®] and IBM TotalStorage products	www.ibm.com/storage/support/
IBM Publications Center	www.ibm.com/e-business/linkweb/publications/servlet/pbi.wss
IBM Redbooks [®] publications	www.redbooks.ibm.com/

Related accessibility information

To view a PDF file, you need Adobe Acrobat Reader, which can be downloaded from the Adobe website:

www.adobe.com/support/downloads/main.html

How to order IBM publications

The IBM Publications Center is a worldwide central repository for IBM product publications and marketing material.

The IBM Publications Center offers customized search functions to help you find the publications that you need. Some publications are available for you to view or download at no charge. You can also order publications. The publications center displays prices in your local currency. You can access the IBM Publications Center through the following website:

www.ibm.com/e-business/linkweb/publications/servlet/pbi.wss

Sending your comments

Your feedback is important in helping to provide the most accurate and highest quality information.

To submit any comments about this book or any other Storwize V7000 documentation:

- Go to the feedback page on the website for the Storwize V7000 Information Center at publib.boulder.ibm.com/infocenter/storwize/ic/index.jsp?topic=/com.ibm.storwize.v7000.doc/feedback.htm. There you can use the feedback page to enter and submit comments or browse to the topic and use the feedback link in the running footer of that page to identify the topic for which you have a comment.
- Send your comments by email to starpubs@us.ibm.com. Include the following information for this publication or use suitable replacements for the publication title and form number for the publication on which you are commenting:
 - Publication title: *IBM Storwize V7000 CIM Agent Developer's Guide*
 - Publication form number: GC27-2292-01

- Page, table, or illustration numbers that you are commenting on
- A detailed description of any information that should be changed

Chapter 1. Introduction to CIM agent

The Common Information Model (CIM) provides an open approach to the design and implementation of storage systems, applications, databases, networks, and devices. The CIM agent is a set of standards that is developed by the Distributed Management Task Force (DMTF).

The following information introduces the Storage Management Initiative Specification (SMI-S), the CIM agent, the IBM Storwize V7000, and the CIM agent for the Storwize V7000. Functional views of the CIM agent object models illustrate the architecture and specific functions of the CIM agent.

Storage Management Initiative Specification

The Storage Management Initiative Specification (SMI-S) is a design specification of the Storage Management Initiative (SMI) that is launched by the Storage Networking Industry Association (SNIA).

The SMI-S specifies a secure and reliable interface that is used by storage management systems to identify, classify, monitor, and control physical and logical resources in a storage area network (SAN). The interface integrates the various devices to be managed in a SAN and the tools used to manage them.

SMI-S is based on a number of existing technologies or industry standards that include the following:

Common Information Model (CIM)

An object model for data storage and management that is developed by the Distributed Management Task Force (DMTF). CIM makes it possible to organize devices and components of devices in an object-oriented pattern.

Web-Based Enterprise Management (WBEM)

A tiered enterprise management architecture that is also developed by the DMTF. This architecture provides the management design framework that consists of devices, device providers, the object manager, and the messaging protocol for the communication between client applications and the object manager. In the case of the CIM, the object manager is the CIM Object Manager (CIMOM) and the messaging protocol is the CIM over HTTP technology. The CIM over HTTP approach specifies that the CIM data is encoded in XML and sent in specific messages between the client applications and the CIMOM over the Internet Protocol network in a SAN.

Service Location Protocol (SLP)

A directory service that the client application uses to locate the CIMOM.

Intended to be an industry standard, SMI-S extends the generic capabilities of the CIM, the WBEM, and the SLP to implement storage networking interoperability. For example, the WBEM provides provisions for security, resource-locking management, event notification, and service discovery.

For more information about SMI-S conforming profiles that are supported by CIM agent for the Storwize V7000 and writing standards-based implementations, see the following website:

CIM agent

The Common Information Model (CIM) agent is a set of standards that is developed by the Distributed Management Task Force (DMTF).

The CIM provides an open approach to the design and implementation of storage systems, applications, databases, networks, and devices.

The CIM specifications provide the language and the methodology for describing management data. For example, CIM schema 2.7 for Managing Storage Arrays specifies how to configure the management environment for data management in a common way. The CIM defines common object classes, associations, and methods. Member vendors can use those objects and extend them to specify how data can be processed and organized in a specific managed environment.

CIM agent concepts

This information describes the basic terminology and functions of the Common Information Model (CIM) agent object models.

The CIM agent specifications use the following concepts and terminology to describe the object models:

Association

A class with two references that define a relationship between two referenced objects.

Class The definition of an object within a specific hierarchy. An object class can have properties and methods and serve as the target of an association.

Indication

An object representation of an event.

Instance

An individual object that is the member of a class. In object-oriented programming, an object that is created by instantiating a class.

Managed Object Format (MOF)

A language for defining Common Information Model (CIM) schemas.

Method

A way to implement a function on a class.

Namespace

The scope within which a CIM schema applies.

Object path

An object that consists of a namespace path and a model path. The namespace path provides access to the CIM implementation that the CIM agent manages, and the model path provides navigation within the implementation.

Property

An attribute that is used to characterize instances of a class.

Qualifier

A value that provides additional information about a class, association, indication, method, method parameter, instance, property, or reference.

Reference

A pointer to another instance that defines the role and scope of an object in an association.

Schema

A group of object classes defined for and applicable to a single namespace. Within the CIM agent, the supported schemas are the ones that are loaded through the Managed Object Format (MOF) compiler.

CIM agent components

With a Common Information Model (CIM) agent, application programmers can use common building blocks rather than proprietary software or device-specific programming interfaces to manage CIM-compliant devices. Standardization of the way that applications manage storage provides easier storage management.

Components

A CIM agent involves the following components:

agent code

An open-systems standard that interprets CIM requests and responses as they transfer between the client application and the device.

CIM object manager (CIMOM)

The common conceptual framework for data management that receives, validates, and authenticates the CIM requests from the client application. It then directs the requests to the appropriate component or device provider. Storwize V7000 is based on the Open Pegasus version 2.9.0 CIMOM.

client application

A storage management program that initiates CIM requests to the CIM agent for the device.

device The storage server that processes and hosts the client application requests.

device provider

A device-specific handler that serves as a plug-in for the CIM. That is, the CIMOM uses the handler to interface with the device.

Service Location Protocol (SLP)

A directory service that the client application calls to locate the CIMOM.

CIM agent for Storwize V7000

The Common Information Model (CIM) agent for Storwize V7000 serves as a configuration interface for the Storwize V7000.

The CIM agent consists of the following main components:

- CIM object manager (CIMOM)
- Service Location Protocol (SLP) agent
- Storwize V7000 provider

Examples of how the CIM agent works

The Common Information Model (CIM) agent can be used to provide common building blocks to manage CIM-compliant devices.

Typical CIM agent configuration

Figure 1 shows how a typical CIM agent works.

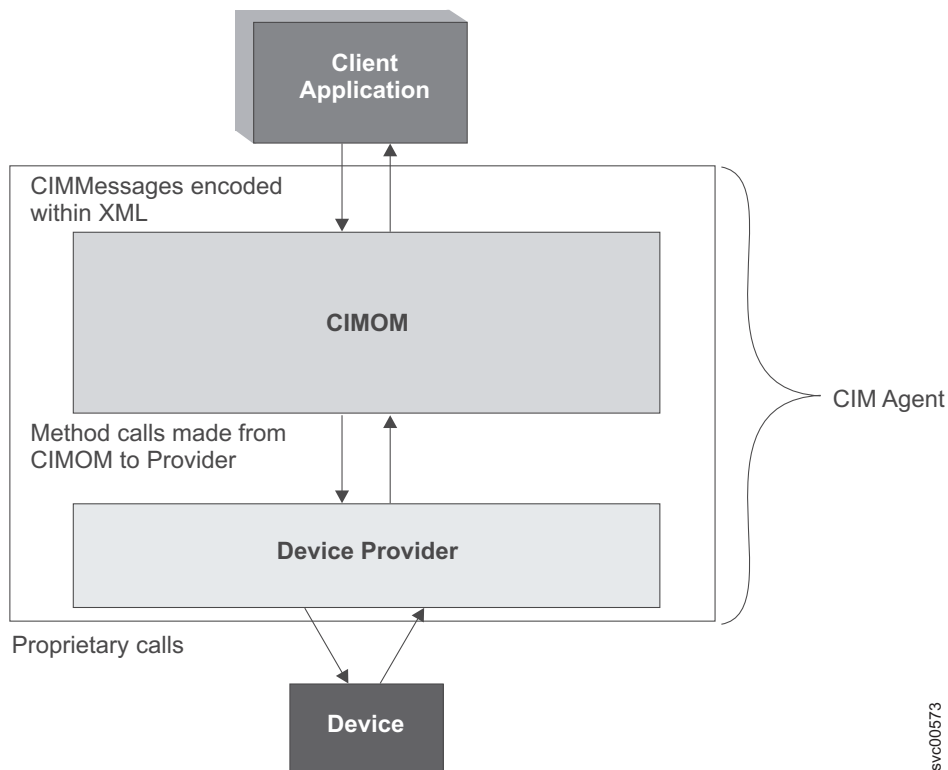

Figure 1. A typical CIM agent at work

A typical configuration for your CIM client is to use the CIMOM that is located at `https://cluster_ip port 5989` with `namespace=/root/ibm`. The standard secure port is 5989. You can also use `namespace=interop`, which is the standard SMI-S namespace.

The client application sends CIM requests to the CIMOM. As requests arrive, the CIMOM validates and authenticates each request. It then directs the requests to the appropriate functional component of the CIMOM or to a device provider. To satisfy client application requests, the provider makes calls to a device-unique programming interface on behalf of the CIMOM.

The management application can obtain an instance of the `RemoteServiceAccessPoint` from the CIMOM. This instance is used by the management application to access the web user interface.

CIM agent configuration with Service Location Protocol

If you use Service Location Protocol (SLP) to discover the CIMOM, the client application locates the CIMOM by calling an SLP directory service. When the CIMOM is first invoked, it registers itself to the SLP Service agent and supplies its location, IP address, port number, and the type of service that it provides. A string that describes the CIM agent access point is registered.

The following output provides an example of the registered string:

```
service:wbem:https://<CIM Agent IP>:<port number>
```

The SLP provides the following attributes:

```
template-type=wbem
template-version=1.0
template-description=This template describes the attributes used for
advertising WBEM servers.
template-url-syntax=https://9.47.24.91:5989
service-location-tcp=https://9.47.24.91:5989
service-hi-name=IBM Storwize(r)
  V7000 CIMOM
service-hi-description=IBM Storwize
  V7000 CIM Agent Version 6.3.0.xxx
service-id=IBMTSSVC:9.47.24.91
ProtocolVersion=1.2
CommunicationMechanism=cim-xml
FunctionalProfilesSupported=Basic Read, Basic Write, Instance Manipulation,
Association, Traversal, Query Execution, Qualifier Declaration, Indications
AuthenticationMechanismSupported=Basic
Namespace=/root/ibm
Interop=/root/ibm
MultipleOperationsSupported=false
RegisteredProfilesSupported=SNIA:Storage Virtualizer,SNIA:Storage Virtualizer:
Access Points,SNIA:Storage Virtualizer:Block Services,SNIA:Storage Virtualizer:
Cascading,SNIA:Storage Virtualizer:Copy Services,SNIA:Storage Virtualizer:
FC Initiator Ports,SNIA:Storage Virtualizer:FC Target Ports,SNIA:Storage
Virtualizer:Health,SNIA:Storage Virtualizer:Masking and Mapping,SNIA:Storage
Virtualizer:Multiple Computer System,SNIA:Storage Virtualizer:Physical Package,
SNIA:Storage Virtualizer:Software,SNIA:Storage Virtualizer:Location,SNIA:
Storage Virtualizer:Block Server Performance,SNIA:Storage Virtualizer:iSCSI
Target Ports,SNIA:Storage Virtualizer:Disk Drive Lite,SNIA:Storage Virtualizer:
Extent Composition,SNIA:Storage Virtualizer:Disk Sparing,SNIA:Server,SNIA:Server:
Profile Registration,SNIA:Server:Object Manager Adapter,SNIA:Server:Indication,
SNIA:SMI-S
```

With this information, the client application starts to directly communicate with the CIMOM.

CIM agent configuration on the console and the clustered system

The CIMOM resides on the Storwize V7000 clustered system. The management GUI does not use the CIMOM that is on the clustered system. Other IBM storage management tools continue to use the CIMOM that is on the clustered system.

Figure 2 on page 6 shows how this CIMOM configuration is defined.

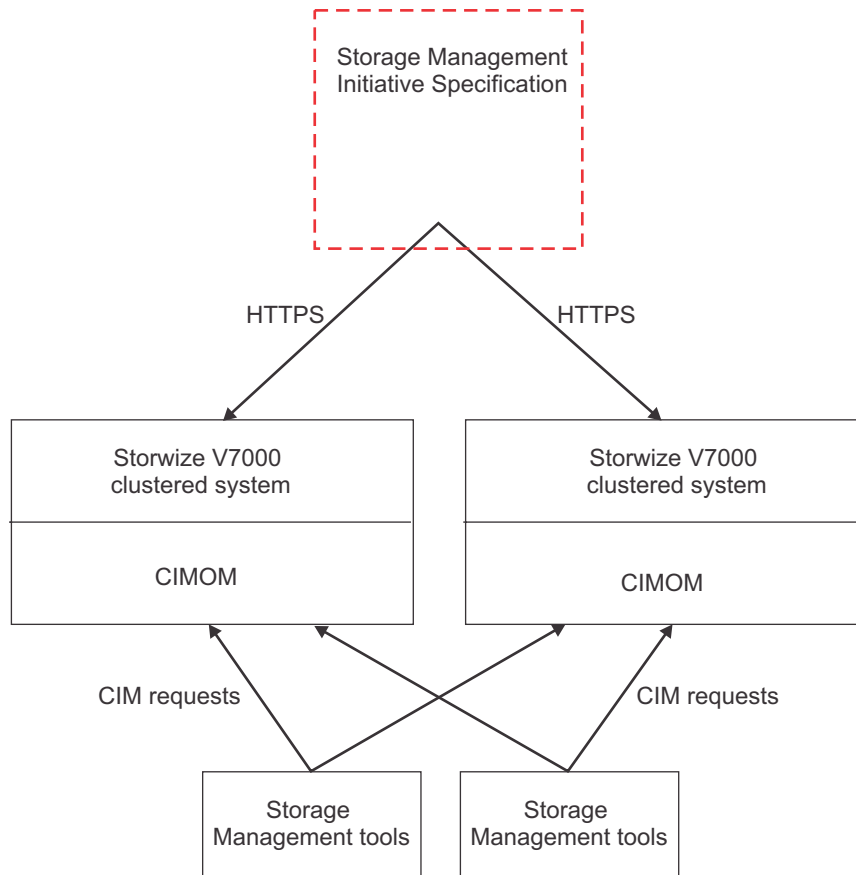

syc00553_stwz

Figure 2. CIMOM on the clustered system

Storwize V7000 CIMOM programming

CIM object manager (CIMOM) programming provides the opportunity to handle multiple connections from multiple sources while maintaining security. CIM clients connect to the CIMOM with a user name and password and then invoke methods to run commands.

The creation of a CIM client requires a suitable framework such as the Java WBEM Service project and the SBLIM CIM Client for Java. There are also implementations in other languages, including C++ and Python. For more information, see the Java WBEM Services website at:

wbemservices.sourceforge.net/

Figure 3 on page 7 shows a simple Java program that connects to a Storwize V7000 CIMOM.

```

import java.util.*;

import javax.wbem.cim.*;
import javax.wbem.client.*;

public class ITSOCient {
    public static void main(String[] args)
    {
        String username = args[0];
        String password = args[1];
        String masterConsoleIP = args[2];
        String masterConsoleSecurePort = args[3];
        UserPrincipal user = new UserPrincipal(username);
        PasswordCredential pwd = new PasswordCredential(password);
        CIMNameSpace ns = new CIMNameSpace("https://" +
            masterConsoleIP + ":" +
            masterConsoleSecurePort + "/root/ibm");

        CIMClient client = null;
        try
        {
            System.out.println("Connecting to CIMOM");
            client = new CIMClient(ns,user,pwd);
        }
        catch (CIMException e)
        {
            // Handle the CIM Exception
            e.printStackTrace();
        }
    }
}

```

Figure 3. Java program for connecting to a Storwize V7000 CIMOM

To view the complete Managed Object Format (MOF) documentation, including the CIM agent style pages, select the documentation information from the following website:

Support for Storwize V7000 website at www.ibm.com/storage/support/storwize/v7000

How Storwize V7000 concepts map to CIM concepts

To administer the Storwize V7000 through the CIM object manager (CIMOM), it is important to understand the relationship between Storwize V7000 and Common Information Model (CIM) concepts.

Table 4 shows how these concepts relate to one another.

Table 4. Relating Storwize V7000 concepts to CIM concepts

Storwize V7000 concept	CIM	
	CIM name	CIM concept
System	IBMTSSVC_Cluster	Class
SystemName	ElementName	Property
System ID	Name	Property
VDisk	IBMTSSVC_StorageVolume	Class
VDisk ID	DeviceID	Property
FlashCopy® Consistency Group (regular)	IBMTSSVC_FlashCopyStorageSynchronizedSet	Class

Table 4. Relating Storwize V7000 concepts to CIM concepts (continued)

Storwize V7000 concept	CIM	
	CIM name	CIM concept
FlashCopy Consistency Group (autodelete)	IBMTSSVC_CloneCopyStorageSynchronizedSet	Class
FlashCopy Mapping	IBMTSSVC_LocalStorageSynchronized	Association
FlashCopy Mapping Status	SyncState	Property
mkfcmap	AttachReplica	Method
preparefcmap	ModifySynchronization	Method
startfcmap	ModifySynchronization	Method
Remote Copy Consistency Group (Global Mirror)	IBMTSSVC_AsyncCopyStorageSynchronizedSet	Class
Remote Copy Consistency Group (Metro Mirror)	IBMTSSVC_SyncCopyStorageSynchronizedSet	Class
Remote Copy relationship	IBMTSSVC_RemoteStorageSynchronized	Association
Remote Copy relationship state	NativeState	Property
mkrrelationship	AttachReplica	Method
startrelationship	ModifySynchronization	Method
mdisk	IBMTSSVC_BackendVolume	Class
mdiskgrp	IBMTSSVC_ConcreteStoragePool	Class
mkvdisk	CreateOrModifyElementFromStoragePool	Method
mkmdiskgrp	CreateOrModifyStoragePool	Method
rmvdisk	ReturnToStoragePool	Method
rmdiskgrp	DeleteStoragePool	Method
Host (with regard to ports)	IBMTSSVC_StorageHardwareID	Class
Host (with regard to volume (VDisk) mapping)	IBMTSSVC_ProtocolController	Class
mkvdiskhostmap	ExposePaths	Method
rmvdiskhostmap	HidePaths	Method
mkhost	CreateStorageHardwareID	Method
rmhost	DeleteStorageHardwareID	Method
DiskDrive	IBMTSSVC_DiskDrive	Class
Array	IBMTSSVC_Array	Class
mkarray	CreateOrModifyElementFromElements	Method
charray	CreateOrModifyElementFromElements	Method
rmarray	DeleteArray	Method
Enclosure	IBMTSSVC_Enclosure	Class

Functional diagrams of the Common Information Model agent

The functional diagrams of the Common Information Model (CIM) agent object model show specific functions that the CIM agent provides, including storage configuration service, Copy Services, LUN masking, and security. The diagrams also illustrate the architecture of the CIM Agent for the Storwize V7000.

Access point subprofile

The access point subprofile of the Common Information Model (CIM) agent for the Storwize V7000 consists of several basic classes.

Figure 4 shows the basic classes (building blocks) for the model.

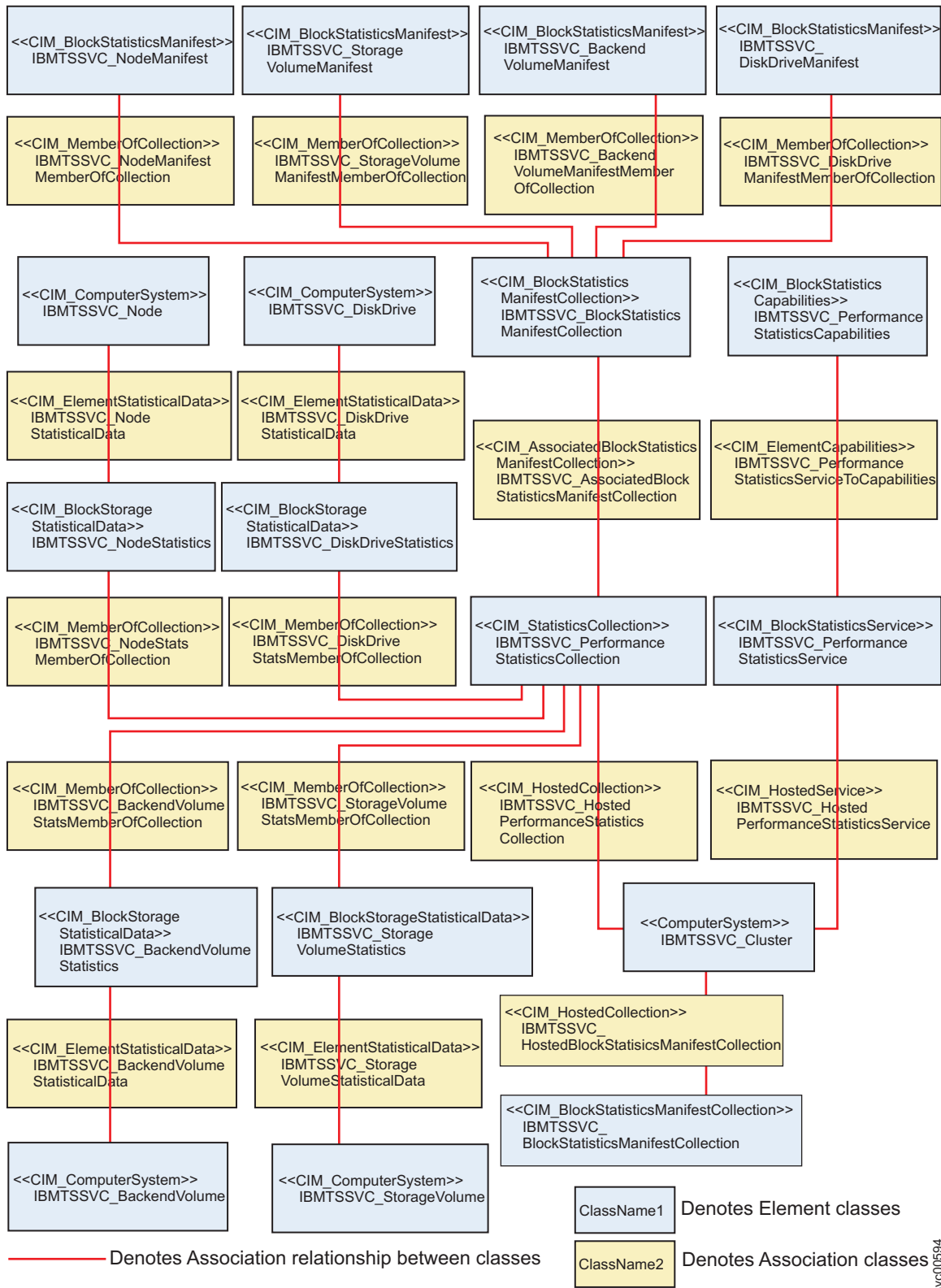

Figure 4. High-level overview of the access point subprofile of the CIM agent

Block server performance subprofile

The block server performance subprofile describes performance statistics.

Figure 5 on page 10 describes the performance statistics of IBMTSSVC_Node, IBMTSSVC_StorageVolume, IBMTSSVC_BackendVolume, and IBMTSSVC_DiskDrive.



svc00594

Figure 5. Block server performance subprofile

Block services profile

You can use several object classes to manipulate storage pools.

The block services profile allocates back-end storage volumes into storage pools and then creates storage volumes.

Figure 6 on page 12 provides a high-level overview of the object classes that you can use for pool manipulation.

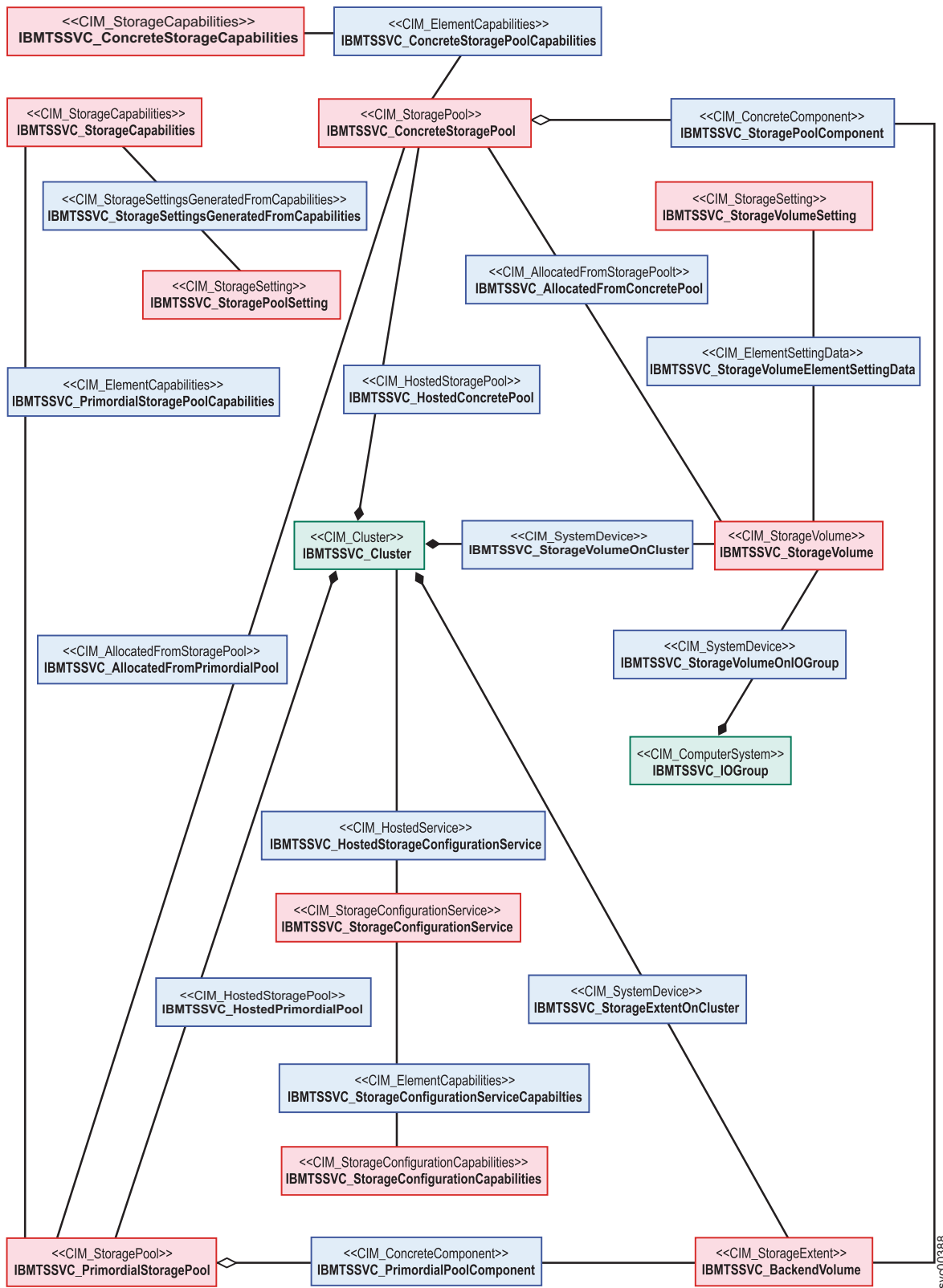

Figure 6. High-level overview of block services.

RAID support for block services

RAID array classes provide support for the block services profile.

This diagram illustrates the classes and their relationships in regard to RAID (array) functions in the block services profile.



Figure 7. RAID support for block services

Clustered system subprofile

There are several classes and associations that provide the function of a clustered-system service.

Figure 8 on page 14 shows the classes and associations that provide the function of a clustered-system service.

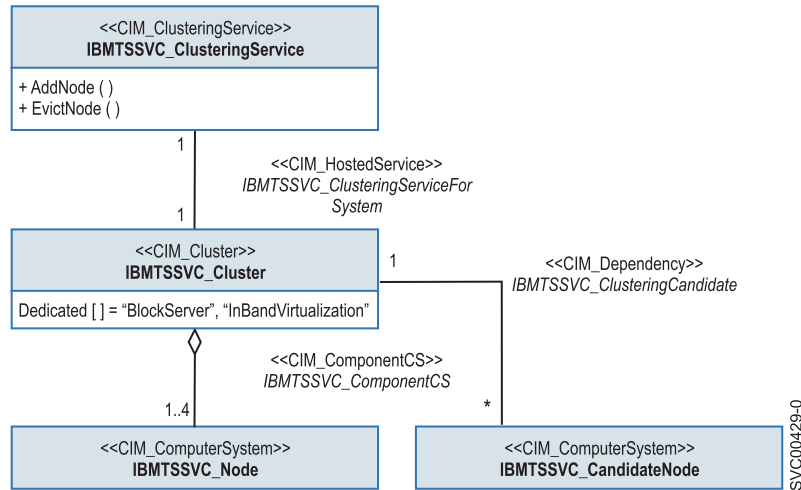
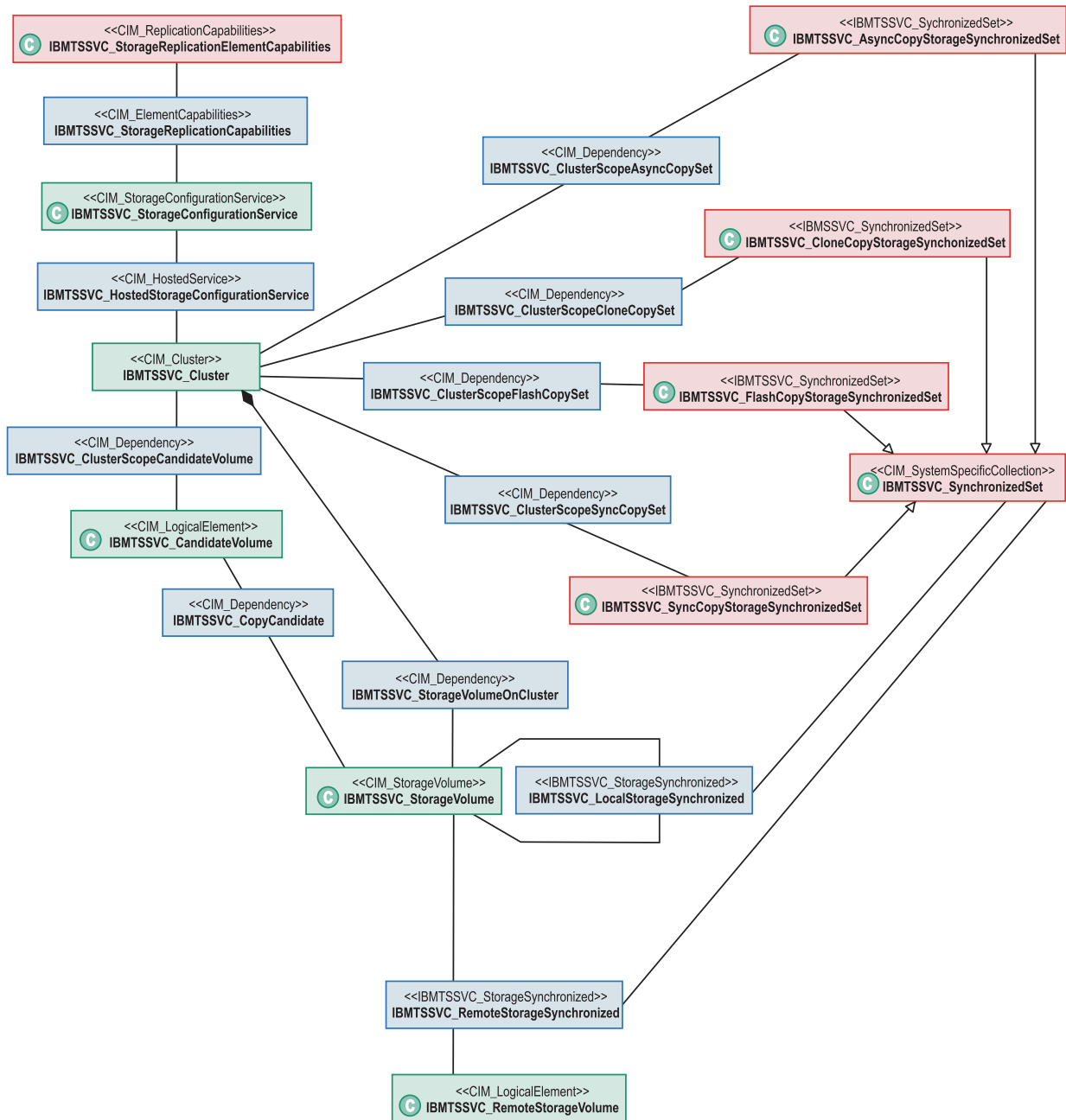

Figure 8. Class diagram of clustered-system instance

Copy Services

The `IBMTSSVC_StorageConfigurationService` class provides the methods to create copy relationships.

Figure 9 on page 15 shows the object classes that provide FlashCopy, Metro Mirror, and Global Mirror Copy Services.



SVC00389-2

Figure 9. Class diagram of copy services instances

Disk drive lite profile

The disk drive is the primary hardware element of the disk drive lite profile.

Figure 10 on page 16 shows the basic elements of the disk drive lite profile.

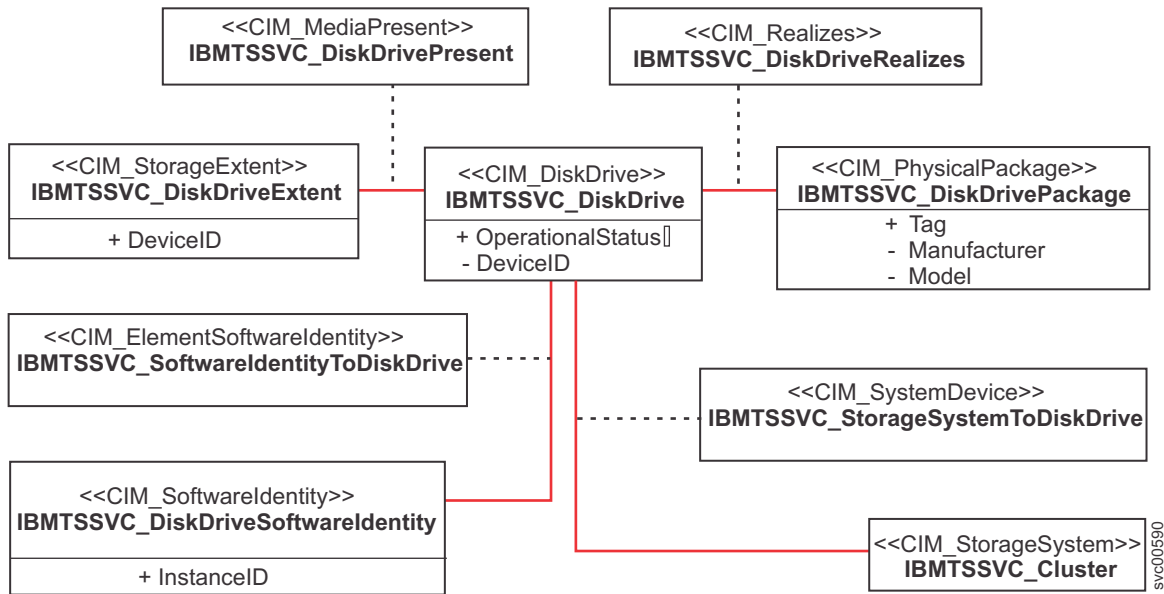

Figure 10. Overview of the Unified Modeling Language elements of the disk drive lite profile

Disk-drive sparing

Disk-drive sparing has a basic structure associated with RedundancySet.

The disk-drive sparing RedundancySet structure is composed of one instance class and three association classes:

Instance class:

- IBMTSSVC_StorageRedundancySet (Extended from CIM_StorageRedundancySet)

Association classes:

- IBMTSSVC_StoragePoolExtentDependency represents the association between IBMTSSVC_DiskDriveExtent and IBMTSSVC_ConcreteStoragePool.
- IBMTSSVC_HostedRedundancySet represents the association between IBMTSSVC_StorageRedundancySet and IBMTSSVC_Cluster.
- IBMTSSVC_MemberOfRedundancySet represents the association between IBMTSSVC_DiskDriveExtent and IBMTSSVC_StorageRedundancySet. The DiskDriveExtents form the redundancy set of a StoragePool.

Disk-drive sparing CIM structure

The disk-drive sparing CIM structure consists primarily of the DiskDriveExtent and the StorageRedundancySet.

The interrelationships of the various components are shown in Figure 11 on page 17.

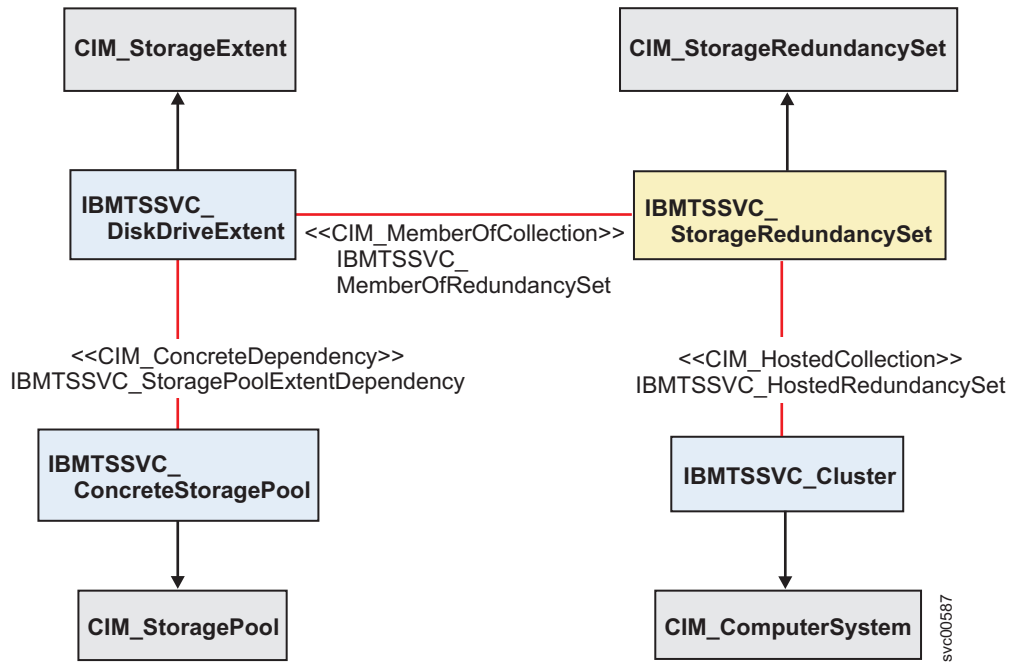

Figure 11. Disk-drive sparing CIM structure

Spare disk-drive extents

The DiskDriveExtents are used with a failed realization.

The DiskDriveExtents used to replace a DiskDriveExtent whose realization has failed are associated to the RedundancySet using an IsSpare association, as shown in Figure 12.

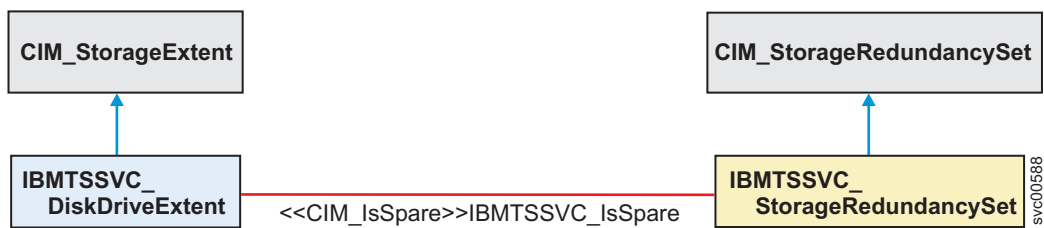

Figure 12. IsSpare association

Class IBMTSSVC_IsSpare represents the association between the IBMTSSVC_DiskDriveExtent to be used as spares and the IBMTSSVC_StorageRedundancySet.

Disk-drive failure association

A failed DiskDriveExtent can be spared.

The DiskDriveExtents associated can be used to spare or replace other DiskDriveExtents that might fail, as shown in Figure 13 on page 18.



Figure 13. Association during failure

In this relationship between the new DiskDriveExtent and the array being rebuilt, a failed DiskDriveExtent is being spared by the new one. The IBMTSSVC_Spared associations remain until the sparing process is complete.

Enclosure profile

The enclosure is the primary hardware element of the enclosure profile.

Figure 14 shows the basic elements of the enclosure profile.

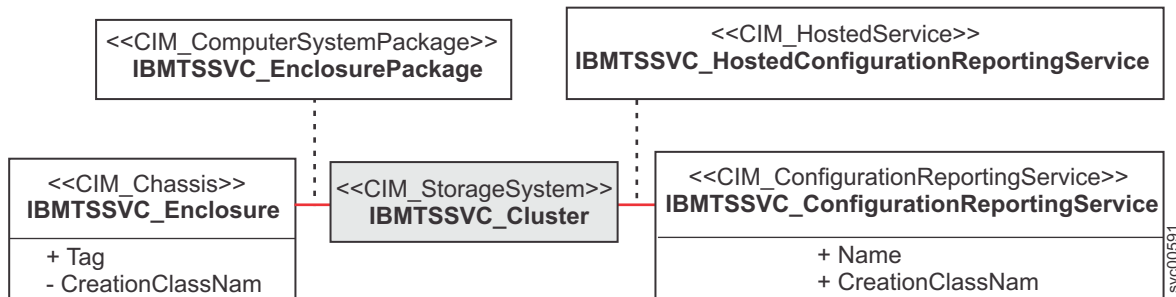

Figure 14. Elements of the enclosure profile

Extent composition subprofile

The extent composition subprofile links CompositeExtents and StorageExtents.

The extent composition subprofile is used by the block services package to optionally virtualize exposable block storage elements from the underlying primordial storage pool. The abstraction is presented as a representative hierarchy of extents. Figure 15 on page 19 represents the relationships among the disk drive lite, extent composition, and array subprofiles.

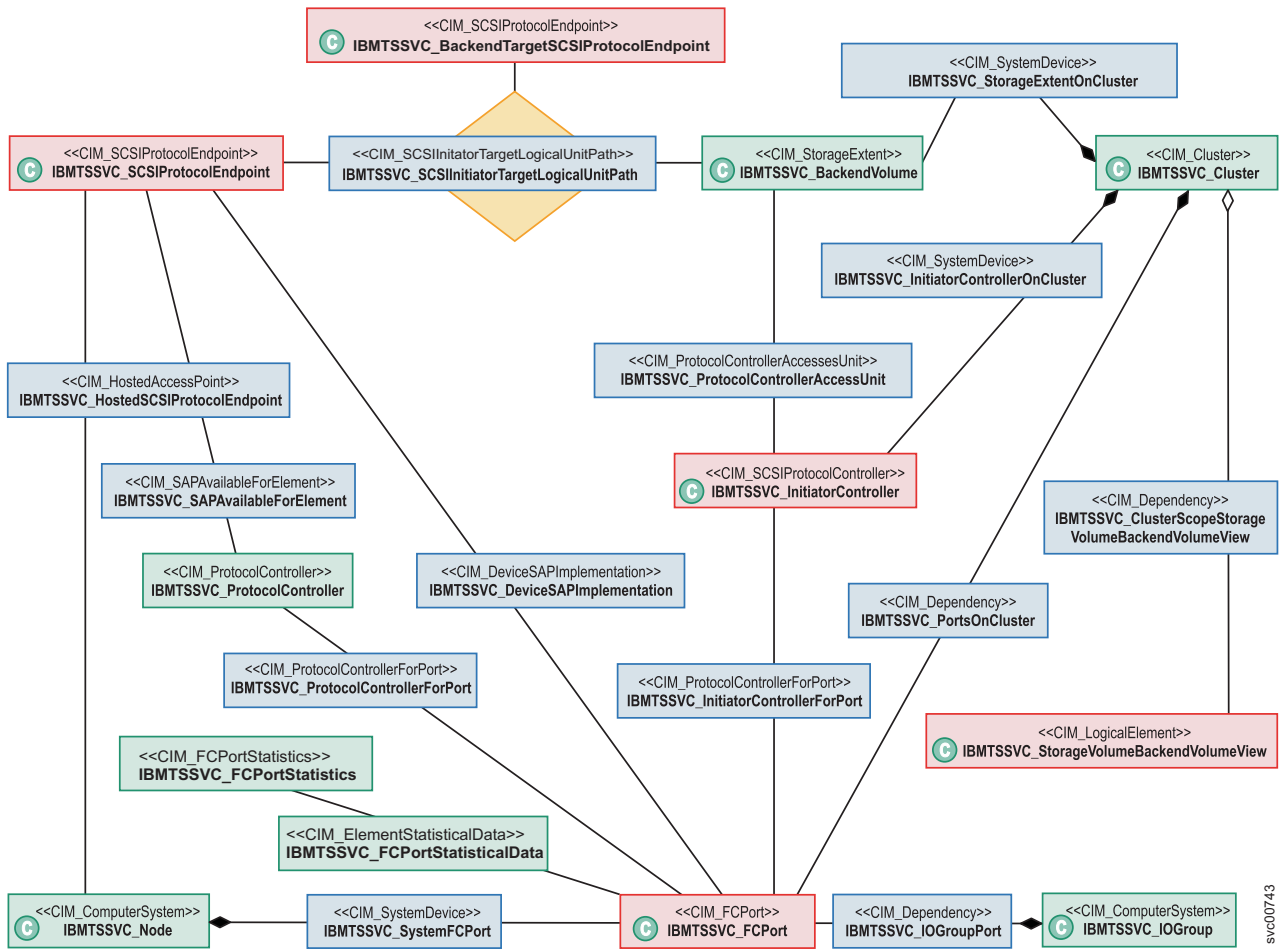

Figure 16. Class diagram of FC port instances

Interop profile

The interop profile contains the classes that are used to find the registration profiles from the interop namespace.

Figure 17 on page 21 shows the classes and associations for the interop profile. In this profile, IBMTSSVC_HostedAccessPointInterop represents the relationship of IBMTSSVC_CIMXMLCommunicationMechanismInterop and IBMTSSVC_MasterConsole.

IBMTSSVC_CIMXMLCommunicationMechanismInterop is registered in the interop namespace. IBMTSSVC_MasterConsole is registered in the root/ibm namespace.

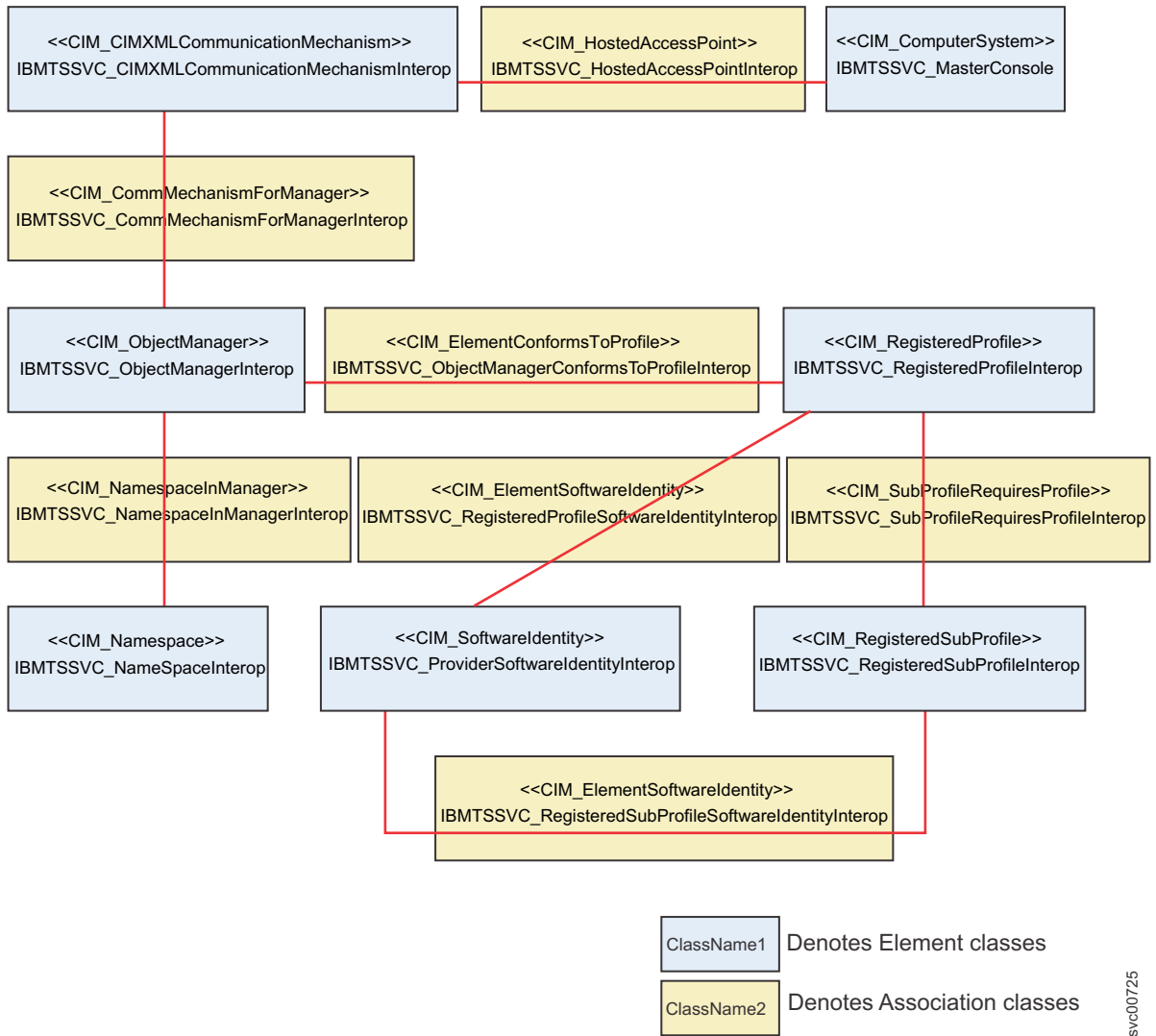

svc00725

Figure 17. Class diagram of interop instances

iSCSI relationships

The iSCSI-specific aspects of a target device include instance and association classes.

Figure 18 on page 22 shows the iSCSI-specific aspects of a target device.

Job control profile

The job control profile contains classes that are used to monitor asynchronous commands that format, migrate, or run copy operations on a device.

Figure 19 shows the classes and associations for the job control profile.

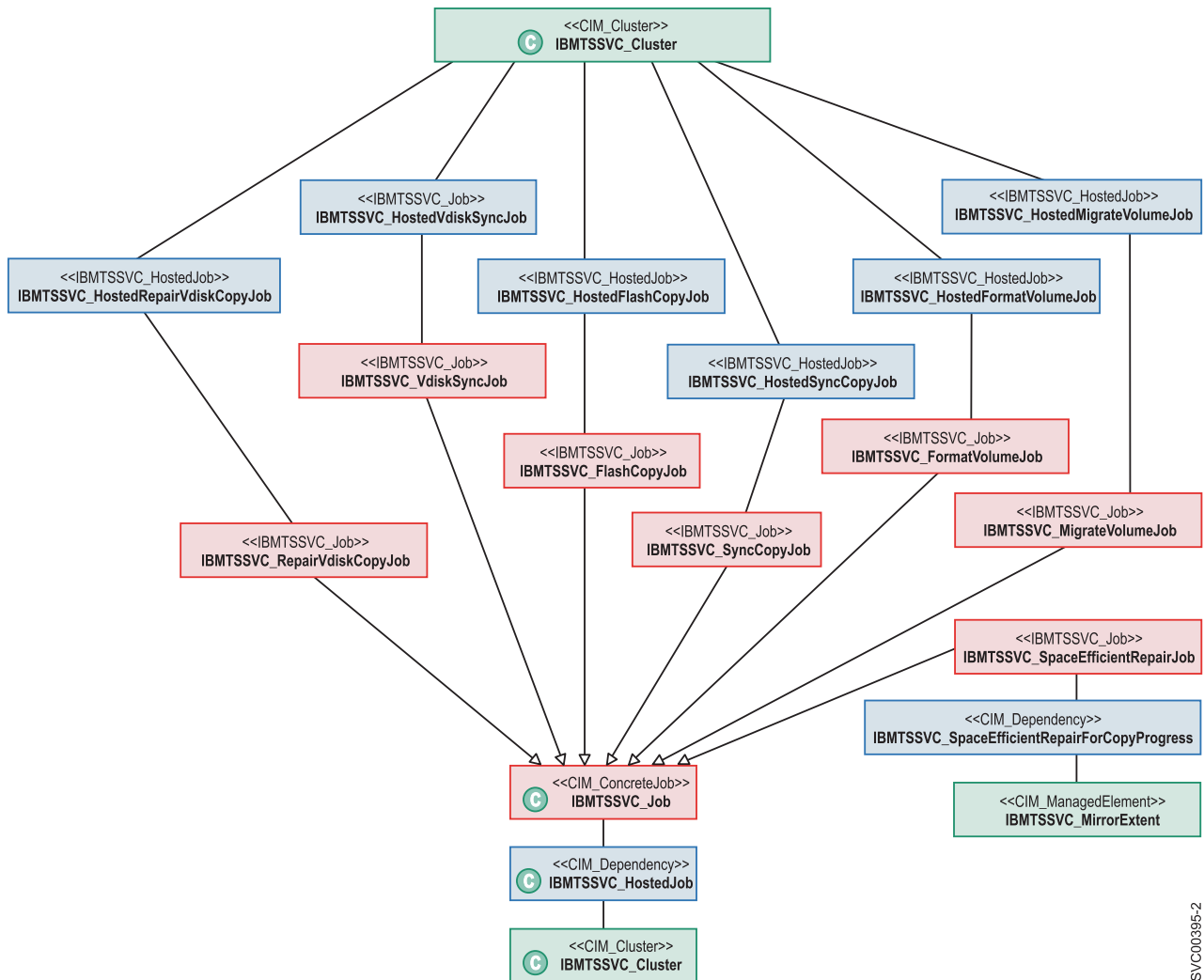

Figure 19. Class diagram of job control instances

Location subprofile

The location subprofile represents the relationship between location and physical package.

Figure 20 on page 24 shows the basic elements of the location subprofile.

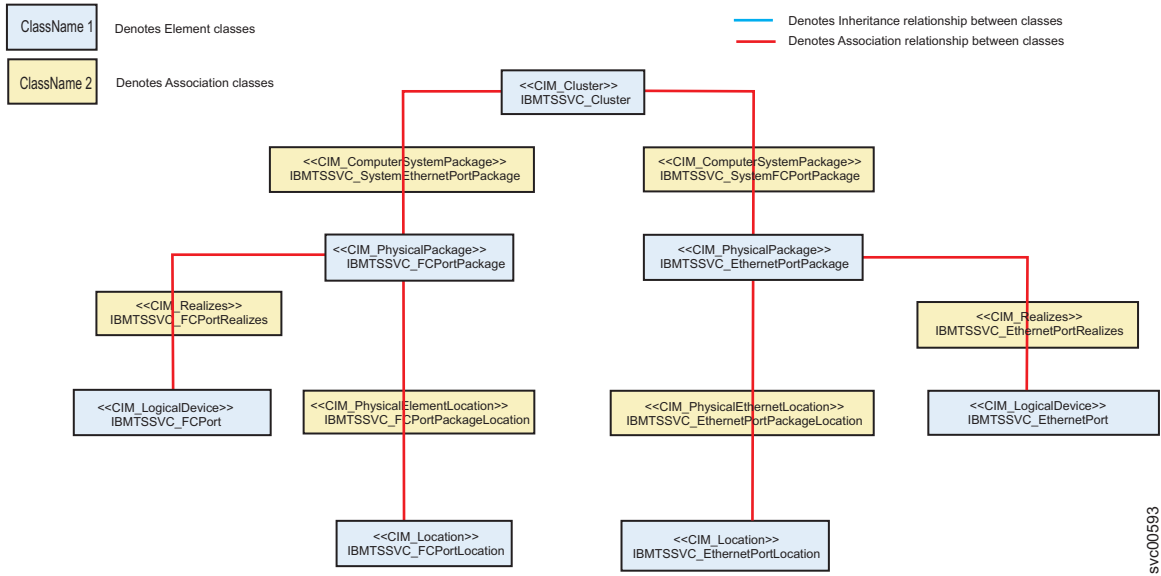

Figure 20. Overview of the relationship between location and physical package

In Figure 20, the class in yellow blocks denotes the association class. For example, IBMTSSVC_FCPortRealizes is the association between IBMTSSVC_FCPort and IBMTSSVC_FCPortPackage. The class in blue blocks denotes the element class.

Masking and mapping profile

The masking and mapping profile provides an interface to create, modify, delete, and mask hosts.

Figure 21 on page 25 shows the classes and associations for the masking and mapping profile.

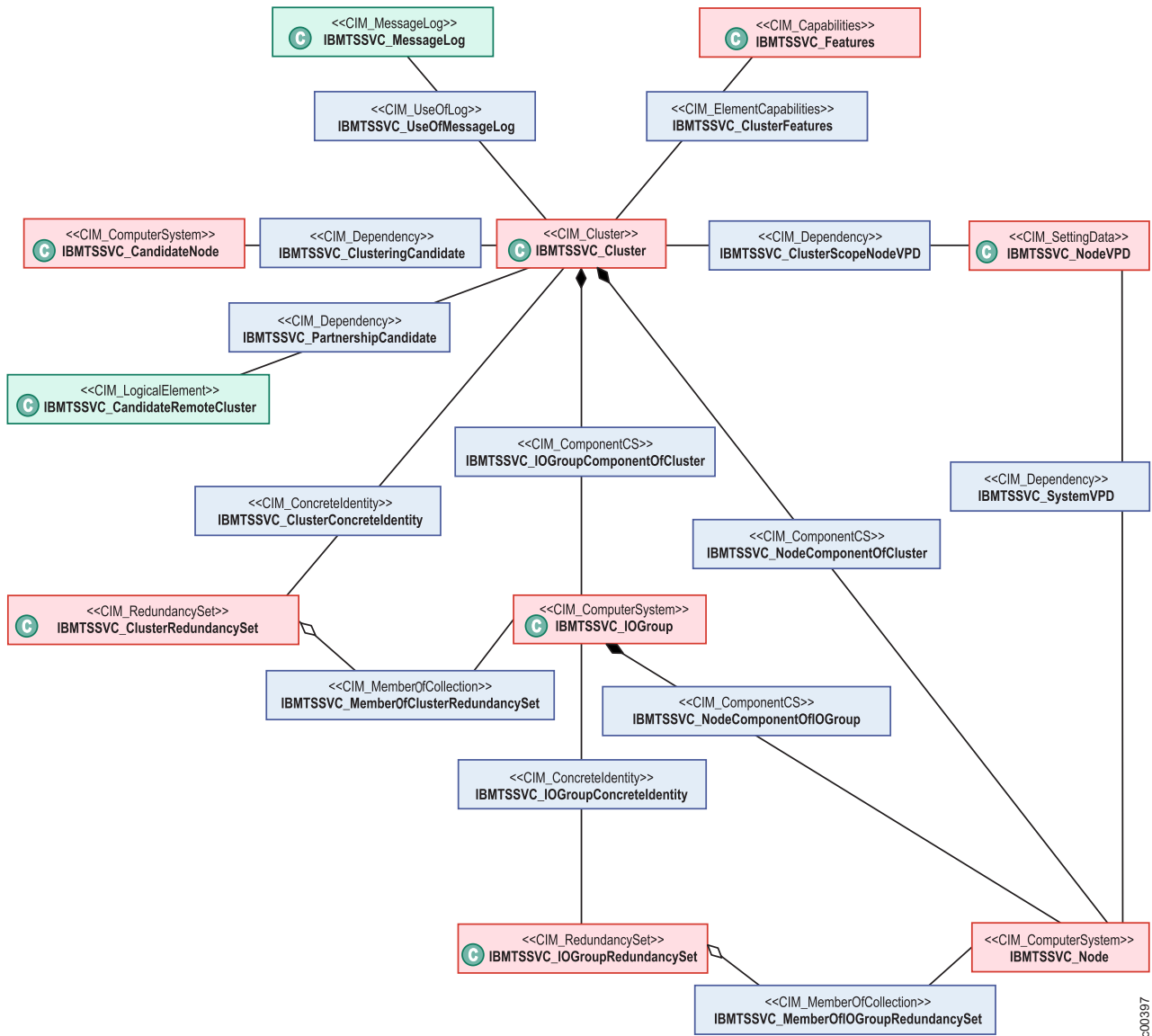

Figure 22. Class diagram of multiple computer system instances

Object manager adapter profile

The primary function of the object manager adapter profile is to turn the indication service on or off.

Figure 23 on page 27 shows the basic elements of the Object Manager Adapter profile.

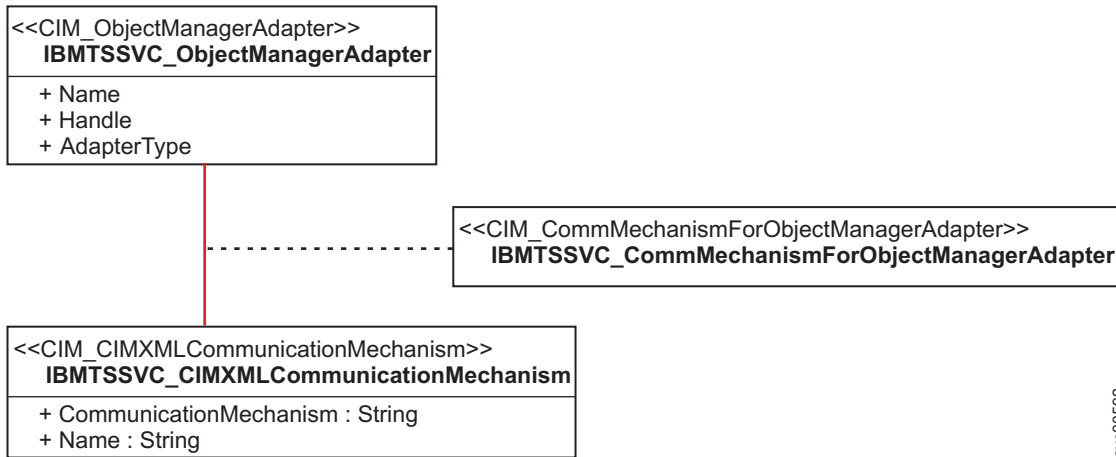

Figure 23. Overview of the Unified Modeling Language elements of the object manager adapter profile

Physical package

The physical package of the Common Information Model (CIM) agent for the Storwize V7000 consists of two classes and two association classes.

Figure 24 shows the basic classes (building blocks) for the model.

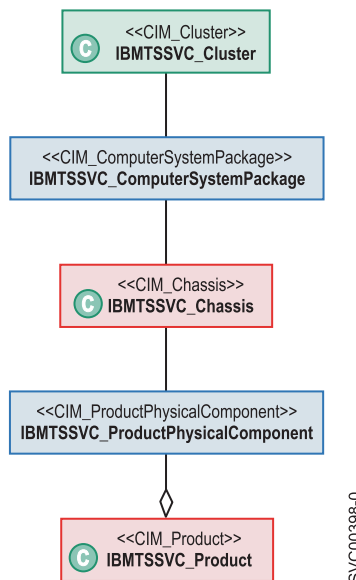

Figure 24. High-level overview of the physical package of the CIM agent for the Storwize V7000.

Server profile

The server profile of the Common Information Model (CIM) agent for the Storwize V7000 consists of several basic classes.

Figure 25 on page 28 shows the basic classes (building blocks) for the model.

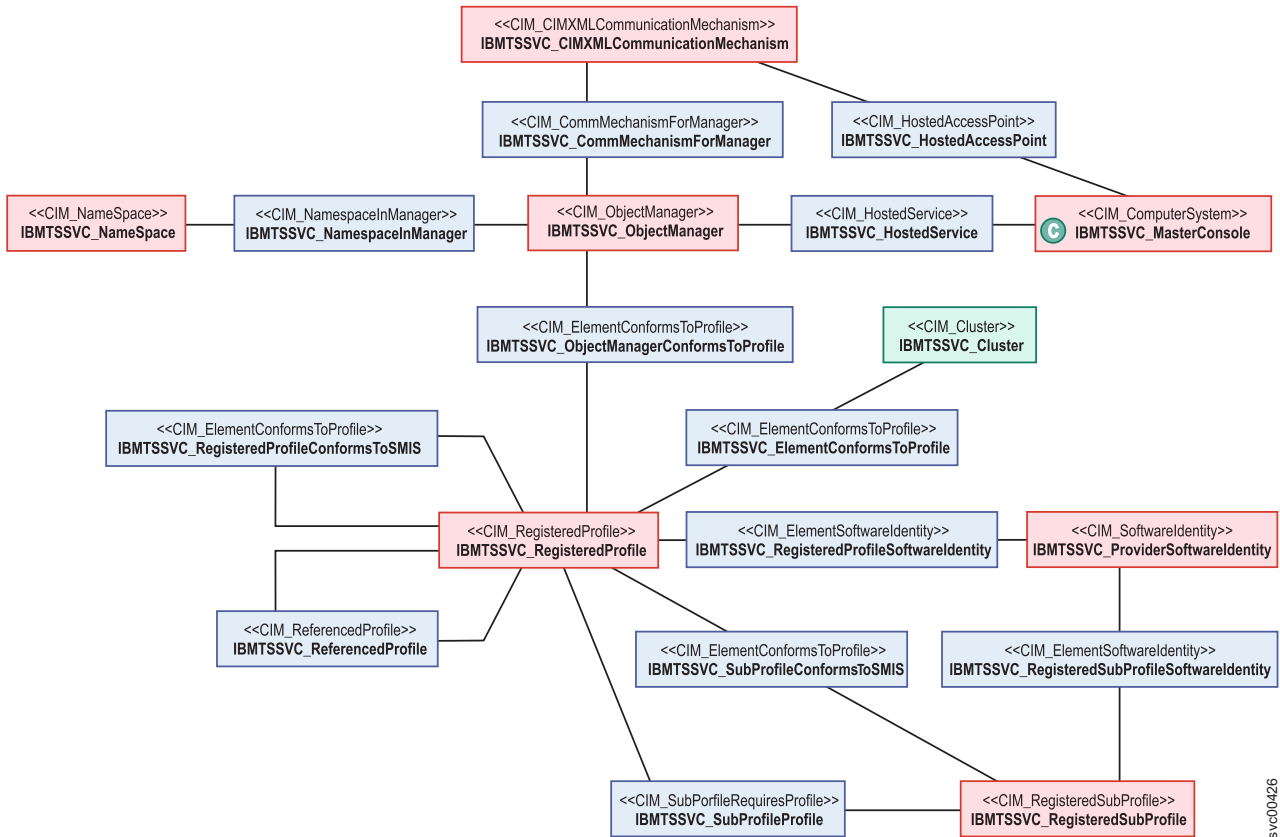

Figure 25. High-level overview of the server profile of the CIM agent for the Storwize V7000.

Software profile

The software profile is used by the CIM agent to model the software for the Storwize V7000 clustered system and for the CIM agent.

Figure 26 shows the classes and associations for the software profile.

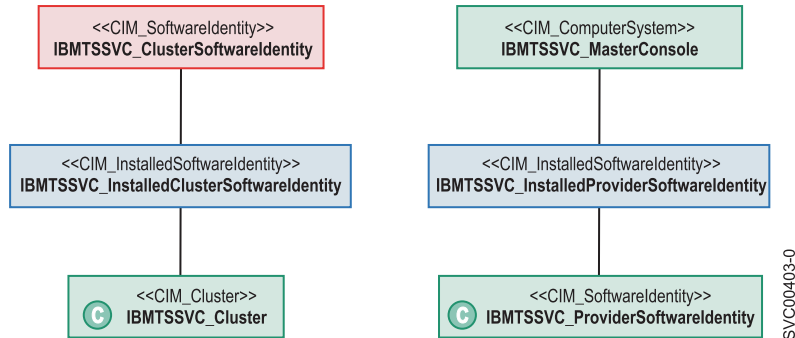

Figure 26. Class diagram of software instances

Storage volume mirroring

You can create two mirrored copies of a storage volume to increase data availability. The volume remains online and available as long as one copy is available.

Figure 27 shows the classes and associations that are involved in mirroring storage volumes.

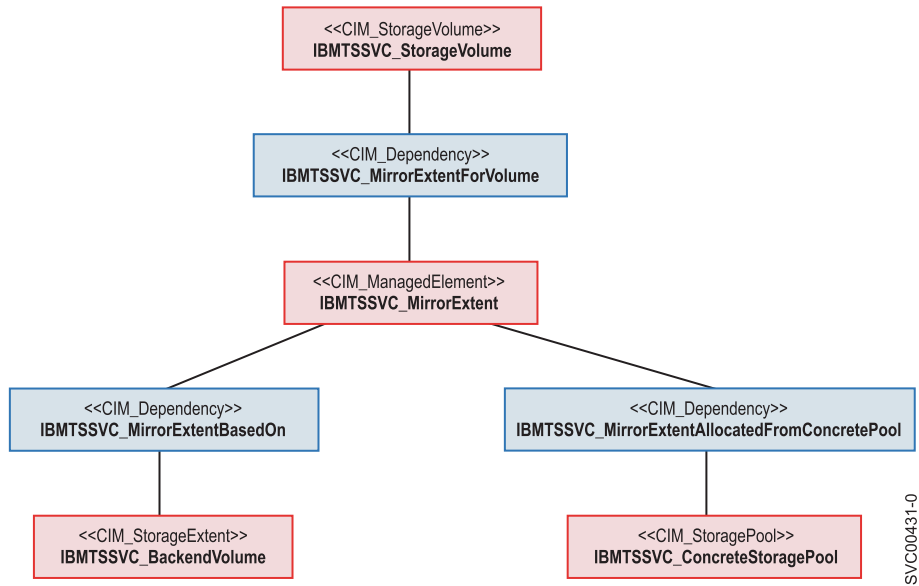

Figure 27. Classes and associations in mirroring storage volumes

Chapter 2. Performing storage configuration tasks

Storage configuration is the mapping of the back-end storage to the storage pools and the allocation of volumes from those pools. After you complete the initial setup of the Storwize V7000, you use the Common Information Model (CIM) agent object class instances to complete basic storage configuration tasks.

In the CIM agent for the Storwize V7000, storage configuration involves three layers of objects: back-end, middle, and front-end. The objects in the *back-end* layer contain the back-end controllers and volumes, those in the *middle* layer contain the storage pools, and those in the *front-end* layer contain the storage volumes that are exposed to the hosts.

The `IBMTSSVC_StorageConfigurationService` class provides the `CreateOrModifyStoragePool()` and `CreateOrModifyElementFromStoragePool()` methods for performing basic storage configuration.

You can use the `CreateOrModifyStoragePool()` method to create an `IBMTSSVC_StoragePool` and add or remove an `IBMTSSVC_BackendVolume`. You can use the `CreateOrModifyElementFromStoragePool()` method to allocate, expand, or shrink an `IBMTSSVC_StorageVolume` from an `IBMTSSVC_ConcreteStoragePool`.

To complete basic storage configuration, perform the following tasks:

1. Add a node to the clustered system.
2. Add a candidate control enclosure to the system.
3. Create an array from the disk drive.
4. Create a storage pool.
5. Modify the storage pool.
6. Create a storage volume.
7. Modify a storage volume.

Creating a new storage pool

The `IBMTSSVC_StorageConfigurationService` class provides the methods for creating a new `IBMTSSVC_ConcreteStoragePool`.

To create a new `IBMTSSVC_ConcreteStoragePool` instance, follow these steps:

1. Obtain the reference (`CIMObjectPath`) of an `IBMTSSVC_StorageConfigurationService` instance that is associated with the `IBMTSSVC_Cluster` in which you will create the new storage pool using one of the following two methods:
 - Obtain the reference of the `IBMTSSVC_StorageConfigurationService` instance directly. There is only one instance obtained by enumeration because CIMOM is embedded in the clustered system.
 - Obtain the reference of the `IBMTSSVC_StorageConfigurationService` instance by traversing the `IBMTSSVC_HostedStorageConfigurationService` association.
2. Invoke the `IBMTSSVC_StorageConfigurationService.CreateOrModifyStoragePool` method while you specify the `InExtents[]` parameter with a list of `IBMTSSVC_BackendVolume` instances.

The `InExtents[]` parameter is a string array that contains the representation of the `CIMObjectPath` to an `IBMTSSVC_BackendVolume`.

You can also just specify the size, and the CIM agent performs a best-fit heuristic to match it. You can specify the name of the pool by using the `ElementName` parameter and the block size by using the `BlockSize` parameter.

Modifying a storage pool

You can modify an `IBMTSSVC_ConcreteStoragePool` instance by changing the pool name and adding or removing an `IBMTSSVC_BackendVolume` instance from the pool.

To modify an `IBMTSSVC_ConcreteStoragePool` instance, follow these steps:

1. Select the `IBMTSSVC_ConcreteStoragePool` instance that you want to modify from an `IBMTSSVC_Cluster`.
2. Identify the `IBMTSSVC_StoragePoolSetting` instance that contains the parameter settings of the `IBMTSSVC_ConcreteStoragePool` Setting instance. You can do this by calling the `IBMTSSVC_StorageCapabilities.CreateSetting()` method or by enumerating the `IBMTSSVC_StoragePoolSetting` that is associated through `IBMTSSVC_StorageSettingsGeneratedFromCapabilities` to the `IBMTSSVC_StorageCapabilities` that is associated to the `IBMTSSVC_ConcreteStoragePool` that is being modified.
3. Modify the name of the selected `IBMTSSVC_ConcreteStoragePool` by calling `IBMTSSVC_StorageConfigurationService.CreateOrModifyPool` with a new element name.
4. If necessary, you can further modify the `IBMTSSVC_ConcreteStoragePool` by adding or removing an `IBMTSSVC_BackendVolume` instance to the pool.

Creating a new storage volume

In the Common Information Model (CIM) agent for the Storwize V7000, the `IBMTSSVC_StorageConfigurationService` class provides all the methods that are required for creating, modifying, and deleting an `IBMTSSVC_StorageVolume` instance.

To create a new `IBMTSSVC_StorageVolume` instance, follow these steps:

Use the `CreateOrModifyElementFromStoragePool()` method on the `IBMTSSVC_Cluster` to which you will assign the new volume to create the new `IBMTSSVC_StorageVolume` with the following parameter specifications:

- The `Virtualization Type` is set using the `VirtualizationType` parameter (0,1,2 for striped, sequential, or image).
- A `Format` flag can be used to specify that the volume is formatted on creation or expansion.
- You can specify the `BackendVolumes` to place the extents for the volume using the `BackendVolume REF` parameter.
- The `PreferredNode` parameter is used to set the preferred node for the volume.
- The `UnitDeviceID` parameter can be used to set the Volume's Unit Device ID on clustered systems that run software level 4.1.0 or higher.
- The `ElementName` parameter can be used to set the Volumes Name at creation.
- The `Autoexpand` parameter

1. Set `ElementType` to 2:

1

- An `ElementType` of 2 creates a standard storage volume.
2. Set `Size` to the preferred volume size in bytes.
 3. Obtain the reference (`CIMObjectPath`) of the `IBMTSSVC_ConcreteStoragePool` instance from which you will allocate an `IBMTSSVC_StorageVolume`.
 4. Set `InPool` to the reference (obtained in the previous step) of the pool from which the volume will be allocated.

The following additional parameters are examples of those that are available as part of the Volume Mirroring feature or Thin-Provisioned Volume feature.

Autoexpand

Used to attempt to maintain a fixed amount of unused real capacity on the volume, which is called the *contingency capacity*. The capacity is initially set to the *real capacity*, which is assigned when the volume is created. If you modify the real capacity, the contingency capacity is reset to be the difference between the *used capacity* and the *real capacity*.

Copies

Indicates the number of mirrored copies to create. Specify either 1 or 2.

Grainsize

Sets the grain size of a thin-provisioned volume. This is valid only if `RealSize` is set. Valid options include 32, 64, 128, or 256.

Import

Used to request the Storwize V7000 to import a thin-provisioned storage volume from the storage pool.

IsSpaceEfficient

Flag that is used to indicate that the created volumes are thin-provisioned volumes. This does not apply to a modify operation.

RealSizeBytes and RealSizePercent

Indicates the real size of a thin-provisioned copy. These parameters cannot be used together.

WarningSizeBytes

Indicates the set point of used capacity at which point a warning is triggered. This parameter cannot be used with the **WarningSizeBytes** parameter.

WarningSizePercent

Indicates the ratio of used capacity versus the volume virtual capacity that triggers a warning. This parameter cannot be used with the **WarningSizeBytes** parameter.

Creating a RAID array

You can create a RAID array using local drives.

To create a RAID array, follow these steps:

1. Obtain the reference (`CIMObjectPath`) of an `IBMTSSVC_StorageConfigurationService` instance that is associated with the `IBMTSSVC_Cluster` in which you will create the new RAID array using one of the following two methods:
 - Obtain the reference of the `IBMTSSVC_StorageConfigurationService` instance directly. There will be only one instance obtained by enumeration because CIMOM is embedded in the clustered system.

- Obtain the reference of the IBMTSSVC_StorageConfigurationService instance by traversing the IBMTSSVC_HostedStorageConfigurationService association.
2. Invoke the IBMTSSVC_StorageConfigurationService CreateOrModifyElementFromElements method.

You must specify the following parameters:

- The InElements [] parameter with a list of IBMTSSVC_DiskDriveExtent instances. The Extent [] parameter is a string array that contains the representation of the CIMObjectPath to an IBMTSSVC_DiskDriveExtent. Only a disk drive with role of candidate is available for use in an array. To change the role of a disk drive, complete the following steps:
 - a. Obtain the reference (CIMObjectPath) of an IBMTSSVC_StorageConfigurationService instance that is associated with the IBMTSSVC_Cluster
 - b. Invoke the IBMTSSVC_StorageConfigurationService ChangeDriveRole method. You must specify the DiskDrive parameter with the reference of the IBMTSSVC_DiskDrive, and set Use parameter to 1.
- StoragePool parameter with an instance of IBMTSSVC_ConcreteStoragePool, which identifies the StoragePool to add the created RAID array to.
- Goal parameter with an instance of IBMTSSVC_RAIDSetting, which contains the RAID-level information.

You can also specify the StripSize, WriteVerify, and SpareGoal. Also see the BlockServices.mof file for more details. To view the complete Managed Object Format (MOF) documentation, select the documentation information from the following website:

Support for Storwize V7000 website at www.ibm.com/storage/support/storwize/v7000

Chapter 3. Establishing Copy Services relationships

You can use the Common Information Model agent object class instances to establish new Copy Services relationships.

Copy Services

FlashCopy, Global Mirror, and Metro Mirror are Copy Services that are provided by the Storwize V7000.

These Copy Services are available to all supported hosts that are connected to the Storwize V7000.

The FlashCopy service enables you to make an instant, point-in-time copy of a source IBMTSSVC_StorageVolume instance to a target IBMTSSVC_StorageVolume instance.

The synchronous copy service (Metro Mirror) provides a consistent copy of the source IBMTSSVC_StorageVolume on the target IBMTSSVC_StorageVolume. Data is written to the target volume synchronously after it is written to the source volume, both of which can belong to the same IBMTSSVC_Cluster instance or different IBMTSSVC_Cluster instances.

The asynchronous copy service (Global Mirror) provides a copy of the source IBMTSSVC_StorageVolume on the target IBMTSSVC_StorageVolume. Data is written to the target volume asynchronously after it is written to the source volume, both of which can belong to the same IBMTSSVC_Cluster instance or different IBMTSSVC_Cluster instances.

Creating a new FlashCopy relationship between storage volumes

The IBMTSSVC_StorageConfigurationService class provides the methods for establishing a FlashCopy relationship between two IBMTSSVC_StorageVolume instances that are the same size and belong to the same IBMTSSVC_Cluster instance.

To create a FlashCopy relationship between two IBMTSSVC_StorageVolume instances, perform the following steps:

1. Select an IBMTSSVC_StorageVolume instance as the source volume for the preferred FlashCopy relationship.
2. Select a valid IBMTSSVC_StorageVolume as a target.
Make sure that the source IBMTSSVC_StorageVolume and target IBMTSSVC_StorageVolume instances belong to the same IBMTSSVC_Cluster instance.
3. Retrieve the IBMTSSVC_StorageConfigurationService instance that is associated with the IBMTSSVC_Cluster instance to which the selected IBMTSSVC_StorageVolume instances belong.
4. Invoke the IBMTSSVC_StorageConfigurationService.AttachReplica() method with the following parameter specifications:
 - a. Set SourceElement to the reference (CIMObjectPath) of the source IBMTSSVC_StorageVolume.

- b. Set TargetElement to the reference (CIMObjectPath) of the target IBMTSSVC_StorageVolume.
- c. Optionally set ElementName to the name of the synchronization.
- d. Optionally set BackgroundCopyRate to the preferred priority of the background copy rate (0 - 100).
- e. Optionally specify Set to add the newly created FlashCopySynchronization to the set. If you specify a null value, the newly created FlashCopySynchronization will not be a member of a synchronized set.
- f. Optionally set CopyType to 5. This sets AutoDelete to true, which automatically deletes the FlashCopy mapping after the background copy is complete.
- g. If you do not want to automatically delete FlashCopy mappings, Set CopyType to 4.

The source IBMTSSVC_StorageVolume and target IBMTSSVC_StorageVolume instances are now connected through the IBMTSSVC_LocalStorageSynchronized association.

Creating a FlashCopy relationship for a synchronized set

The IBMTSSVC_StorageConfigurationService class provides the methods for establishing a FlashCopy relationship between two IBMTSSVC_StorageVolume instances and then adding it to an IBMTSSVC_FlashCopyStorageSynchronizedSet instance.

To create a FlashCopy relationship between two IBMTSSVC_StorageVolume instances and add it to an IBMTSSVC_FlashCopyStorageSynchronizedSet instance, perform the following steps:

1. Select an IBMTSSVC_StorageVolume instance as the source volume for the preferred FlashCopy relationship.
2. Select a valid IBMTSSVC_StorageVolume as a target. Valid volumes can be determined using IBMTSSVC_CandidateVolume.
Make sure that the source IBMTSSVC_StorageVolume and target IBMTSSVC_StorageVolume instances belong to the same IBMTSSVC_Cluster instance.
3. Retrieve the IBMTSSVC_StorageConfigurationService instance that is associated with the IBMTSSVC_Cluster instance to which the selected IBMTSSVC_StorageVolume instances belong.
4. Invoke the IBMTSSVC_StorageConfigurationService.AttachReplica() method with the following parameter specifications:
 - a. Set SourceElement to the reference (CIMObjectPath) of the source IBMTSSVC_StorageVolume.
 - b. Set TargetElement to the reference (CIMObjectPath) of the target IBMTSSVC_StorageVolume.
 - c. Optionally set ElementName to the name of the synchronization.
 - d. Optionally set BackgroundCopyRate to the preferred priority of the background copy rate in percent (0 - 100%).
 - e. Optionally specify Set to add the newly created FlashCopySynchronization to the set. If you specify a null value, the newly created FlashCopySynchronization will not be a member of a synchronized set.

- f. Optionally set CopyType to 5. This sets AutoDelete to true, which automatically deletes the FlashCopy mapping after the background copy is complete.
 - g. If you do not want to automatically delete FlashCopy mappings, set CopyType to 4.
5. Create an IBMTSSVC_FlashCopyStorageSynchronizedSet instance by invoking the IBMTSSVC_StorageConfigurationService.CreateSynchronizedSet() method with the following parameter specifications:
 - a. Set CopyType to 4 (flash).
 - b. Optionally set ElementName to the name of the newly created IBMTSSVC_FlashCopyStorageSynchronizedSet instance.
 6. Add the IBMTSSVC_StorageSynchronized instance to the IBMTSSVC_FlashCopySynchronizedSet instance by invoking the IBMTSSVC_StorageConfigurationService.ModifySynchronizedSet() method with the Operation parameter set to 0 (add). If the FlashCopy added to the set is CopyType 5, the set becomes CopyType 5, and any other FlashCopy mappings that are added to the set must have CopyType 5, or the add fails. Similarly, if a set contains a FlashCopy of CopyType 4, all other FlashCopy mappings in the set must be of CopyType 4 or the modification operation fails.

The synchronization must belong to the same clustered system as the hosting service.

Creating a synchronous copy relationship between volumes in the same clustered system

The IBMTSSVC_StorageConfigurationService class provides the methods for creating a synchronous copy relationship between a source IBMTSSVC_StorageVolume and a target IBMTSSVC_StorageVolume.

Perform the following steps to create the synchronous copy relationship:

1. Select an IBMTSSVC_StorageVolume instance as the source volume for the preferred source volume.
2. Select an IBMTSSVC_StorageVolume instance as the target volume.
3. Obtain the reference (CIMObjectPath) of the IBMTSSVC_StorageConfigurationService instance that is associated with the IBMTSSVC_Cluster instance to which the selected volumes belong.
4. Invoke the IBMTSSVC_StorageConfigurationService.AttachReplica() method with the following parameter specifications:
 - a. Set SourceElement to the reference (CIMObjectPath) of the source IBMTSSVC_StorageVolume instance.
 - b. Set TargetElement to the reference (CIMObjectPath) of the target IBMTSSVC_StorageVolume.
 - c. Optionally set ElementName to the name of the synchronization.
 - d. Set CopyType to 3 for Synchronous and 2 for Asynchronous.

The source IBMTSSVC_StorageVolume instance and the target IBMTSSVC_StorageVolume are now connected through the RemoteStorageSynchronized association.

Creating a synchronous copy relationship between volumes in different clustered systems

The `IBMTSSVC_StorageConfigurationService` class provides the methods for creating a synchronous copy relationship between a source `IBMTSSVC_StorageVolume` instance and a target `IBMTSSVC_RemoteStorageVolume` instance belonging to different `IBMTSSVC_Cluster` instances.

To create a synchronous copy relationship between two volumes with the source located in a local clustered system and the target located in a remote clustered system, perform the following steps:

1. Identify an `IBMTSSVC_Cluster` instance as the source clustered system for the preferred synchronous copy relationship.
2. Obtain the reference (`CIMObjectPath`) of the `IBMTSSVC_StorageConfigurationService` instance that is associated with the source clustered system.
3. Identify the `IBMTSSVC_RemoteCluster` on which you want the synchronous copy to reside by traversing the `IBMTSSVC_RemotePartnership` association.
4. Create a remote clustered system partnership by invoking the `IBMTSSVC_CascadingAllocationService.Allocate()` method with the following parameter specifications:
 - a. Set `RemoteCluster` to the reference (`CIMObjectPath`) of the `IBMTSSVC_RemoteCluster` instance.
 - b. Optionally set `Bandwidth` to the preferred bandwidth in megabytes (MB).Make sure to issue the method from both the source and candidate clustered systems to establish a fully configured partnership; otherwise, the synchronous copy relationship cannot be established.
5. Select an `IBMTSSVC_StorageVolume` as the source volume from the source `IBMTSSVC_Cluster`.
6. Select an `IBMTSSVC_CandidateVolume` as the target volume from the `IBMTSSVC_RemoteCluster`. To determine a candidate volume, use the `IBMTSSVC_CopyCandidate` association from the source volume.

Note: `IBMTSSVC_StorageVolume` instances on the remote clustered system are seen on the local clustered system as a `IBMTSSVC_CandidateVolume` instance.

7. Invoke the `IBMTSSVC_StorageConfigurationService.AttachReplica()` method with the following parameter specifications:
 - a. Set `SourceElement` to the reference (`CIMObjectPath`) of the source `IBMTSSVC_StorageVolume` instance.
 - b. Set `TargetElement` to the reference (`CIMObjectPath`) of the target `IBMTSSVC_CandidateVolume`.
 - c. Optionally set `ElementName` to the name of the synchronization.
 - d. Set `CopyType` to 3.

The source `IBMTSSVC_StorageVolume` instance and the target `IBMTSSVC_StorageVolume` or `IBMTSSVC_RemoteStorageVolume` instance are now connected through the `IBMTSSVC_MasterRemoteStorageSynchronized` association.

Sample code to create and start a FlashCopy mapping

This information demonstrates how CIMOM methods can control the clustered system. The sample code includes a main method from a Java class that is designed to create and start a FlashCopy mapping and other methods that are called from the main method.

In this topic, the term *method* refers to a Java method. The term *Method* (initial capital) refers to a CIM Method.

Java main method

This example shows the Java main method for creating and starting a FlashCopy mapping. The assumption in this example is that your Java program is designed to control the same clustered system every time. It is a relatively simple process to make it more flexible, but that decision is left to you.

```
/*
 * FC Mapping states
 */
private static UnsignedInt16 INITIALIZED = new UnsignedInt16(2);
private static UnsignedInt16 PREPARING = new UnsignedInt16(3);
private static UnsignedInt16 PREPARED = new UnsignedInt16(4);

public static void main(String[] args) throws CIMException
{
    /*
     * First step is to connect to the CIMOM
     */
    UserPrincipal user = new UserPrincipal("superuser");
    PasswordCredential pwd = new PasswordCredential("itso13sj");
    CIMNameSpace ns = new CIMNameSpace("https://9.43.86.115:5989/root/ibm");

    CIMClient client = null;

    client = new CIMClient(ns,user,pwd);

    /*
     * Next, select the clustered system that we are interested in
     */
    CIMInstance chosenCluster = getCluster("ITSOCL1",client);

    /*
     * At this point, the relevant clustered system has been selected
     * and 'chosenCluster' is a CIMInstance of this clustered system
     *
     * Get the Config Service of this clustered system
     */
    CIMObjectPath cService = getConfigService(chosenCluster, client);

    /*
     * Now, get all of the Volumes in this clustered system
     */
    Map<Integer,CIMObjectPath> volumesById = getVolumes(chosenCluster,client);

    /*
     * Select the FlashCopy Source
     *
     * In this case, Volume 10 is our source
     * Volume 11 is our target
     */
    CIMObjectPath fcSrc = volumesById.get(new Integer(10));
    CIMObjectPath fcTgt = volumesById.get(new Integer(11));/*
    /*
```

```

    * Now create FC Mapping
    */
    CIMValue rc = makeFlashCopyMapping("CIMOMTestMap", fcSrc, fcTgt, cService,
        client,false);

    /*
    * Now that this has been created, we need to get an
    * Object Path to the newly created Association
    */
    List<CIMObjectPath> fcMaps = getFCMappings(fcSrc, client);
    CIMObjectPath fcMapping = fcMaps.get(0);

    /*
    * Now we prepare the FC Mapping
    */
    CIMArgument[] outArgs = new CIMArgument[2];
    rc = prepareFCMapping(cService, fcMapping, client, outArgs);
    System.out.println("Got value:"+
        Integer.toHexString(Integer.parseInt(rc.toString())));

    /*
    * Loop until it is prepared
    */
    CIMValue fcMapState = new CIMValue(PREPARING);
    while(fcMapState.equals(new CIMValue(PREPARING)))
    {
        CIMInstance fcMapInfo = client.getInstance(fcMapping);
        fcMapState = fcMapInfo.getProperty("SyncState").getValue();
    }

    /*
    * Now start the FC Mapping
    */
    rc = startFCMapping(cService, fcMapping, client, outArgs);
    System.out.println("Got value:"+
        Integer.toHexString(Integer.parseInt(rc.toString())));
}

```

getCluster method

The getCluster method returns the CIM instance that corresponds to the clustered system with the supplied name. It does this by enumerating all of the instances of the class IBMTSSVC_Cluster and then checking the name of each one. When one is found that matches the supplied name, an object path to that instance is returned.

```

static private CIMInstance getCluster(String clusterName, CIMClient client) throws
CIMException
{
    CIMInstance chosenCluster = null;
    Enumeration<CIMInstance> clusters =
        client.enumerateInstances(new CIMObjectPath("/root/ibm:IBMTSSVC_Cluster"));

    while(clusters.hasMoreElements())
    {
        CIMInstance possibleCluster = clusters.nextElement();
        String possibleName =
            possibleCluster.getProperty("ElementName").getValue().toString();

        if(possibleName.equals("\""+clusterName+"\""))
        {
            chosenCluster = possibleCluster;
        }
    }
    return chosenCluster;
}

```

getConfigService method

The CIM_StorageConfigurationService class has no direct equivalent on the system, but an instance of this class is required for invoking methods against the system.

In this method, all of the instances that are associated with the supplied clustered system are requested. The association that connects a clustered system to its configuration service is CIM_HostedService. Because a clustered system has only the configuration service associated with it, the first object path in the enumeration is selected.

```
static private CIMObjectPath getConfigService(CIMInstance cluster, CIMClient
client) throws CIMException
{
    Enumeration<CIMObjectPath> configServices = null;
    configServices = client.associatorNames(
        cluster.getObjectPath(),
        "CIM_HostedService",
        "CIM_StorageConfigurationService",
        null,
        null);
    return configServices.nextElement();
}
```

getVolumes method

This method returns a map that relates Volume IDs (as integers) to IBMTSSVC_StorageVolume object paths. The method requests all of the IBMTSSVC_StorageVolume instances that are associated with the provided clustered system instance.

```
static private Map<Integer,CIMObjectPath> getVolumes(CIMInstance cluster, CIMClient
client) throws CIMException
{
    Enumeration<CIMObjectPath> volumes = client.associatorNames(
        cluster.getObjectPath(),
        null,
        "IBMTSSVC_StorageVolume",
        null,
        null);

    Map<Integer,CIMObjectPath> volumesById = new HashMap<Integer, CIMObjectPath>();

    while(volumes.hasMoreElements())
    {
        CIMObjectPath volumeOP = volumes.nextElement();
        CIMValue volumesId = volumeOP.getKey("DeviceID").getValue();
        String idAsString = volumeId.toString();
        String idNoQuotes = idAsString.substring(1, idAsString.length()-1);
        volumesById.put(Integer.parseInt(idNoQuotes), volumeOP);
    }
    return volumesById;
}
```

makeFlashCopyMapping method

This example invokes the AttachReplica against the clustered system configuration service. CIM Methods take typed parameters. In this method, you can see the use of the argRef, argString, and argUint16 methods. These methods act as shortcuts to generating the required arguments for the CIM Method. The AttachReplica method is used for FlashCopy, Metro Mirror and Global Mirror. The CopyType argument indicates which type is required.

```

static private CIMValue makeFlashCopyMapping(
    String name,
    CIMObjectPath source,
    CIMObjectPath target,
    CIMObjectPath configService,
    CIMClient client,
    boolean autodelete) throws CIMException
{
    CIMArgument src = argRef("SourceElement", source, "IBMTSSVC_StorageVolume");
    CIMArgument tgt = argRef("TargetElement", target, "IBMTSSVC_StorageVolume");
    CIMArgument fcName = argString("ElementName",name);
    CIMArgument type = argUint16("CopyType",autodelete?5:4);
    CIMArgument[] inArgs = {src,tgt,fcName,type};
    CIMArgument[] outArgs = new CIMArgument[1];

    CIMValue rc = client.invokeMethod(configService,
        "AttachReplica",
        inArgs,
        outArgs);
    return rc;
}

```

getFCMappings method

The getFCMappings method returns a list of all the FCMappings that are associated with the provided VDisk. This method requests a list of all of the associations that reference the provided IBMTSSVC_StorageVolume. Currently, all of the Java WBEM Services methods of this type return enumerations. This method converts this to a list for ease of use.

```

static private List<CIMObjectPath> getFCMappings(CIMObjectPath volume, CIMClient
client) throws CIMException
{
    Enumeration<CIMObjectPath> assocs = client.referenceNames(
        volume,
        "IBMTSSVC_LocalStorageSynchronized",
        null);
    return Collections.list(assocs);
}

```

prepareFCMapping method

The prepareFCMapping method prepares a FlashCopy mapping. Much like the AttachReplica Method, the ModifySynchronization Method is used to control FlashCopy, Metro Mirror, and Global Mirror. The operation parameter indicates what you actually want to do.

```

private static CIMValue prepareFCMapping(
    CIMObjectPath configService,
    CIMObjectPath fcMapping,
    CIMClient client,
    CIMArgument[] outArgs) throws CIMException
{
    CIMArgument operation = argUint16("Operation", 6);
    CIMArgument synch = argRef("Synchronization",
fcMapping, "IBMTSSVC_FlashCopyStorageSynchronized");

    CIMArgument[] inArgs = new CIMArgument[]{operation,synch};
    outArgs = new CIMArgument[2];

    return client.invokeMethod(configService,
        "ModifySynchronization",
        inArgs,
        outArgs);
}

```

startFCMapping method

The startFCMapping method starts a FlashCopy mapping. This method invokes the ModifySynchronization Method as in “prepareFCMapping method” on page 42 but uses different Operation parameter.

```
private static CIMValue startFCMapping(
    CIMObjectPath configService,
    CIMObjectPath fcMapping,
    CIMClient client,
    CIMArgument[] outArgs) throws CIMException
{
    CIMArgument operation = argUint16("Operation", 4);
    CIMArgument synch = argRef("Synchronization",
    fcMapping, "IBMTSSVC_FlashCopyStorageSynchronized");

    CIMArgument[] inArgs = new CIMArgument[]{operation, synch};
    outArgs = new CIMArgument[2];

    return client.invokeMethod(configService,
        "ModifySynchronization",
        inArgs,
        outArgs);
}
```

Argument generators class

This class uses the following argument generators:

- The **argUint16 method** returns an unsigned 16-bit integer typed argument.

```
static private CIMArgument argUint16(String name, int arg)
{
    return new CIMArgument(
        name,
        new CIMValue(
            new UnsignedInt16(arg),
            new CIMDataType(CIMDataType.UINT16)
        )
    );
}
```

- The **argString method** returns a string-typed argument.

```
static private CIMArgument argString(String name, String str )
{
    return new CIMArgument(
        name,
        new CIMValue(
            str,
            new CIMDataType(CIMDataType.STRING)
        )
    );
}
```

- The **argRef method** returns a reference typed argument. It is a reference to the instance that the provided object path indicates.

```
static private CIMArgument argRef(
    String name,
    CIMObjectPath path,
    String className )
{
    return new CIMArgument(
        name,
        new CIMValue(
            path,

```

```
        new CIMDataType(className)
    );
}
```

Chapter 4. CIM agent network considerations

You can manually set the CIM agent service or the user interface connection information for remote connection access.

RemoteServiceAccessPoint instance

In an environment with multiple network adapters, it might be necessary to manually set the connection data of the RemoteServiceAccessPoint (RSAP) instance.

The IBMTSSVC_RemoteServiceAccessPoint class hosts the information necessary for connection to the web user interface. Management applications can obtain an instance of the RSAP from the CIMOM to launch the user interface through the web.

You can manually set the connection data of the RSAP. This is helpful in an environment with multiple network cards.

To set the connection data, follow these steps:

1. Obtain the IBMTSSVC_Cluster instance.
2. Modify the ConsoleIP and ConsolePort properties through the Modify instance on the clustered system with a property list that contains the Properties that have changed.

The CIM agent automatically updates the RSAP.

Chapter 5. Maintenance and diagnostic tasks

Perform maintenance, informational and diagnostic tasks.

You can perform tasks that provide information about your system.

Getting a list of classes

Use the `IBMTSSVC_ConfigurationReportingService` to get information about enclosure classes.

To retrieve a list of classes that the `IBMTSSVC_Enclosure` supports or has installed, perform the following steps:

1. Select an `IBMTSSVC_Enclosure` instance as the container.
2. Retrieve the `IBMTSSVC_ConfigurationReportingService` instance.
3. Invoke the `IBMTSSVC_ConfigurationReportingService.GetClassTypes ()` method with the following parameter specifications:
 - a. Set `InquiryType` to 2 or 3.
 - b. Set `CIM_ManagedElement` to the reference (`CIMObjectPath`) of the target `IBMTSSVC_Enclosure`.

The returned `ClassTypes[]` contains the class names of the classes that the `IBMTSSVC_Enclosure` supports or has installed. The `IBMTSSVC_Enclosure` currently supports class type `IBMTSSVC_DiskDrive`.

Getting a list of UnitTypes

Use the `IBMTSSVC_ConfigurationReportingService` to get information about enclosure `UnitTypes`.

To retrieve a list of unit types that the `IBMTSSVC_Enclosure` supports or has installed, perform the following steps:

1. Select an `IBMTSSVC_Enclosure` instance as the container.
2. Obtain the `IBMTSSVC_ConfigurationReportingService` instance directly.
3. Invoke the `IBMTSSVC_ConfigurationReportingService.GetClassTypes ()` method with the following parameter specifications:
 - a. Set `InquiryType` to 2 or 3.
 - b. Set `ClassType` to be an entry returned in the `GetClassTypes.ClassTypes` property.
 - c. Set `CIM_ManagedElement` to the reference (`CIMObjectPath`) of the target `IBMTSSVC_Enclosure`.

The returned `UnitTypes[]` contains the unit types of the `ClassTypes` supported or installed in the `IBMTSSVC_Enclosure`.

Getting the number of currently installed units

Use the `IBMTSSVC_ConfigurationReportingService` to get information about the maximum number of supported units or the number of currently installed units for the given `UnitType`, for a given `ClassType`.

To retrieve information about the maximum number of supported units or the number of currently installed units for the given `UnitType`, for a given `ClassType`, perform the following steps:

1. Select an `IBMTSSVC_Enclosure` instance as the container.
2. Retrieve the `IBMTSSVC_ConfigurationReportingService` instance that is associated with the `IBMTSSVC_Cluster` instance to which the selected `IBMTSSVC_Enclosure` instances belong.
3. Invoke the `IBMTSSVC_ConfigurationReportingService.GetClassTypes ()` method with the following parameter specifications:
 - a. Set `InquiryType` to 2 if the supported number is to be returned, or 3 if the currently installed number is to be returned.
 - b. Set `ClassType` to be an entry returned in the `GetClassTypes.ClassTypes` property.
 - c. Set `CIM_ManagedElement` to the reference (`CIMObjectPath`) of the target `IBMTSSVC_Enclosure`.

The returned `NumberOfUnits` is the maximum number of supported or the number of currently installed units of the `ClassTypes` supported or installed in the `IBMTSSVC_Enclosure`.

Using the indication service

You can turn the indication service on or off.

The `IBMTSSVC_ObjectManagerAdapter` class provides the methods for accessing the indication service. To turn the indication service on or off, perform the following steps:

1. Retrieve the `IBMTSSVC_ObjectManagerAdapter` instance that is associated with the `IBMTSSVC_Cluster` instance.
2. Invoke the `IBMTSSVC_ObjectManagerAdapter.StartService()` to start the indication service, and the `IBMTSSVC_ObjectManagerAdapter.StopService()` method to stop the indication service.

Getting performance statistics

The `IBMTSSVC_PerformanceStatisticsService` class provides the method for getting the performance statistics for `IBMTSSVC_Node`, `IBMTSSVC_DiskDrive`, `IBMTSSVC_StorageVolume`, and `IBMTSSVC_BackendVolume`.

To get the performance statistics instance, follow these steps:

1. Obtain the reference (`CIMObjectPath`) of an `IBMTSSVC_PerformanceStatisticsService` instance that is associated with the `IBMTSSVC_Cluster` in which you will get the performance statistics by traversing the `IBMTSSVC_HostedPerformanceStatisticsService` association.
2. Invoke the `IBMTSSVC_PerformanceStatisticsService.GetStatisticsCollection` method to get the performance statistics. Use the following parameter specifications:
 - The `ElementTypes` parameter is used to set the preferred statistics that would be returned according to the preferred source:
 - 4 to return the performance statistics of `IBMTSSVC_StorageVolume`
 - 8 to return the performance statistics of the `IBMTSSVC_DiskDrive`

- 32768 to return the performance statistics of the IBMTSSVC_BackendVolume
- 32769 to return the performance statistics of the IBMTSSVC_Node
- Set ManifestCollection to the reference (CIMObjectPath) of CIM_BlockStatisticsManifestCollection.
- Set StatisticsFormat to 2 (which will return a comma-separated value [CSV]).

The order of statistic properties returned by the GetStatisticsCollection method is the same as the order of properties definitions in the Managed Object Format (MOF) file.

The IBMTSSVC_FCPortStatistics instance, which extends from the CIM_FCPortStatistics instance, provides the statistics for the FCPort. It is defined in Fibre Channel Initiator Port Profile instead of the Block Server Performance profile. The CIM client can get the statistics for the FCPort by enumerating IBMTSSVC_FCPortStatistics instances.

Collecting CIM log files

You can generate CIM log files for diagnostic reporting to the IBM Support Center.

CIMOM logs are collected from the management GUI.

To collect all clustered system logs and CIMOM logs, complete the following steps:

1. Launch the management GUI.
2. Click **Troubleshooting > Support > Download Support Package**.
3. Select the type of log you need and click **Download**.

Note: Setting the highest level of logging on the CIMOM significantly decreases the performance of the CIMOM.

Chapter 6. CIM agent classes, methods, and SMI-S profiles supported

The CIM agent classes are the building blocks of the Common Information Model (CIM) agent and use functions such as storage configuration, Copy Services, and logical unit number (LUN) masking. The Storage Management Initiative Specification (SMI-S) is based on a number of existing technologies that include the CIM.

To view the complete Managed Object Format (MOF) documentation of these classes and methods, select the documentation information from the following website:

Support for Storwize V7000 website at www.ibm.com/storage/support/storwize/v7000

Table 5 identifies the SMI-S profiles that CIM agent for Storwize V7000 supports.

Table 5. SMI-S profiles and subprofiles supported by CIM

Profiles	Subprofiles
SNIA:Storage Virtualizer	SNIA:Storage Virtualizer:Access Points
Storage virtualizers act in a manner similar to RAID arrays but can use storage that is provided by systems that are external to the storage virtualizer and local disks. A storage virtualizer system combines both remote and local storage to create a seamless pool. The virtualization system allocates volumes from the pool for host systems to use. The basic virtualizer system profile provides a read-only view of the system. The various subprofiles extend this description and also enable configuration.	SNIA:Storage Virtualizer:Block Server Performance
	SNIA:Storage Virtualizer:Block Services
	SNIA:Storage Virtualizer:Cascading
	SNIA:Storage Virtualizer:Copy Services
	SNIA:Storage Virtualizer:Disk Drive Lite
	SNIA:Storage Virtualizer:Disk Sparing
	SNIA:Storage Virtualizer:Extent Composition
	SNIA:Storage Virtualizer:FC Initiator Ports
	SNIA:Storage Virtualizer:FC Target Ports
	SNIA:Storage Virtualizer:Health
	SNIA:Storage Virtualizer:iSCSI
	SNIA:Storage Virtualizer:Location
	SNIA:Storage Virtualizer:Masking and Mapping
	SNIA:Storage Virtualizer:Multiple Computer System
	SNIA:Storage Virtualizer:Physical Package
	SNIA:Storage Virtualizer:RAID
SNIA:Storage Virtualizer:Software	

Table 5. SMI-S profiles and subprofiles supported by CIM (continued)

Profiles	Subprofiles
SNIA:Server The server profile is mandatory for all compliant SMI-S servers. The object manager part of the model defines the capabilities of a CIM object manager based on the communication mechanisms that it supports.	SNIA:Server:Profile Registration
	SNIA:Server:Indication Object Manager Adapter

Chapter 7. Return codes

The Common Information Model (CIM) return codes provide information on the status of CIM agent operations.

Common Information Model

Table 6 is a condensed list of possible CIM return codes.

Table 6. Common Information Model return codes

CIM return code	Description	Method	Explanation
0	Success	GetFreeExtends() ListConfiguration Backups()	The parameters are valid. The method completed successfully.
		AddNode()	The node was successfully added.
		CheckValidity()	The information about the certificate was successfully obtained.
		DeleteAccount()	The account was successfully deleted.
		GenerateCIMOM Certificate() EnableAuto Generation() DisableAuto Generation()	The certificate was successfully deleted.
		CreateCode()	The new account was successfully created.
		SetDefault Validity()	The validity was successfully set.
		GrantGlobal Access() GrantSystem Access()	The role was successfully changed.
		CreateGatewayID() AddHardwareIDs ToCollection()	The collection was successfully created.
		DeleteStorage HardwareID()	The StorageHardwareID was successfully deleted.
CreateStorage HardwareID()	The StorageHardwareID was successfully created.		

Table 6. Common Information Model return codes (continued)

CIM return code	Description	Method	Explanation
0	Success (continued)	AttachDevice()	The volume was successfully attached.
		DeleteProtocolController()	The controller was successfully deleted.
		CreateProtocolControllerWithPorts()	A clone was successfully created.
		DeleteRemoteClusterPartnership()	The clustered system partnership was successfully deleted.
		CreateRemoteClusterPartnership()	The clustered system partnership was successfully established.
		DeleteHardwareIDCollection()	The collection was successfully created.
		DeleteCertificate()	The certificate was successfully deleted.
		DeleteSynchronizedSet()	The SynchronizedSet was successfully deleted.
		ModifySynchronisation()	The method was successfully run.
		EvictNode()	The node was successfully evicted.

Table 6. Common Information Model return codes (continued)

CIM return code	Description	Method	Explanation
0	Success (continued)	RestartService()	The CIMOM reboots.
		Shutdown()	The shutdown for the node/clustered system was successfully initiated.
		SetLocale()	The locale was set.
		SetTimezone()	The time zone for the clustered system was successfully set.
		SetPasswords() ModifyReset Password ChangeFeature()	The passwords were changed.
		GetResetPassword ChangeFeature Status()	The feature status was successfully retrieved.
		StartStatistics Collection()	The statistics collection was started.
		DetachDevice()	The volume was successfully detached.
		StopStatistics Collection()	The statistics collection was stopped.
		Backup Configuration()	A backup was successfully created.
		Reload Configuration()	The configuration was reloaded.
		Restore Configuration() Delete Configuration Backup()	A restore was successfully made.
		AttachReplica()	The copy relationship was successfully established.
		CreateSynchronized Set()	The SynchronizedSet was successfully created.
SetPassword()	The password was successfully changed.		

Table 6. Common Information Model return codes (continued)

CIM return code	Description	Method	Explanation
0	Job completed with no error	CreateOrModifyStoragePool()	The pool was successfully created.
		CreateOrModifyElementFromStoragePool()	The volume was successfully created. The pool was successfully modified.
		DeleteStoragePool()	The pool was successfully deleted.
		ReturnToStoragePool()	The volume was successfully deleted.
		RequestDiscovery()	BackendVolume discovery was successful.
		SetIOGroup()	The change was successful.
		SetQuorum()	The method was successful.
		IncludeBackendVolume()	The volume was successfully included.
		ModifySynchronizedSet()	The CLI command was successfully run.
0	Job started successfully	MigrateVolume() MigrateVolumeToImageMode()	The migration job was started.
1	Not supported	SetLocales()	The clustered system does not support locales.
		SetPasswords()	The clustered system does not support password change (CISCO).
		ModifyResetPasswordChangeFeature() GetResetPasswordChangeFeatureStatus()	The clustered system does not support the reset password change feature.
		Upgrade()	The method was called on a 2145 clustered system configuration service.

Table 6. Common Information Model return codes (continued)

CIM return code	Description	Method	Explanation
2	Failed	Dump() Clean() Enter() Exit() Clean() GetDump() ClearLog() GetRecord() GetAllRecords() FixRecord() UnfixRecord() ModifyError Settings() Create2062 Cluster()	An unexpected error occurred. A CLI command failed.
		GetDump()	Failure during command processing. The file was not found.
		Reload Configuration()	Failed to reload the configuration.
		CreateCode()	Failed to create the account.
		GrantGlobal Access() GrantSystem Access()	Failed to change the role.
		SetPassword()	Failed to change the password.
		DeleteAccount()	Failed to delete the account.
2	Unknown error	GenerateCIMOM Certificate() DeleteCertificate()	Failed to generate new certificate due to provider internal reasons.
		EnableAuto Generation() DisableAuto Generation()	Failed due to provider internal reasons.
		SetDefault Validity()	Failed to set validity.
		CheckValidity()	Failed to obtain information about certificate.
4	Failed	GenerateCIMOM Certificate() DeleteCertificate()	Unexpected error occurred. Failed to generate new certificate due to truststore problems.

Table 6. Common Information Model return codes (continued)

CIM return code	Description	Method	Explanation
5	Wrong Parameter Set	Delete Configuration Backup()	The wrong number or type of parameters were passed. The given backup could not be found.
		Modify Synchronisation()	The wrong number or type of parameters were passed or other parameter checking failed.
		CreateCode() GrantGlobal Access() SetPassword() GrantSystem Access() DeleteAccount() DeleteCertificate() SetDefault Validity() CheckValidity()	One of the parameters is not valid.
5	Parameter not valid	Dump(), GetDump() PositionToFirst RecordRoot() GetRecord() FixRecord() UnfixRecord()	One of the mandatory parameters is missing.
		ModifyIP Address() Create2062 Cluster() Add2062Cluster() Add2145Cluster() Reset2062Node() Reload2062Node()	One of the mandatory parameters is missing or not valid.
		CreateOrModify StoragePool() CreateOrModify ElementFrom StoragePool() Delete StoragePool() ReturnTo StoragePool()	At least one of the parameters is not valid.
		CreateGatewayID() GenerateCIMOM Certificate()	One of the parameters was not valid.
		PositionAtRecord()	One of the mandatory parameters is missing or having a negative number of records is not supported.
6	CopyType not supported	ModifySynchronized Set()	The type of copy passed in was different from 3 or 4.

Table 6. Common Information Model return codes (continued)

CIM return code	Description	Method	Explanation
6	Operation not supported	ModifySynchronizedSet()	The operation code submitted is not valid for the copy type of the synchronized set.
6	SynchronizedSet is not empty	DeleteSynchronizedSet()	There are still StorageSynchronized associations in the set. All StorageSynchronized associations must be removed before deletion of the set can be run or the Force flag must be set.
6	User ID already exists	CreateCode()	The user ID that you submitted exists in another account.
6	In use	GenerateCIMOMCertificate()	Failed to generate new certificate. Existing certificate is still valid and in use.
7	StorageSynchronized not in the Set		The synchronized storage does not exist in the set.
8	StorageSynchronized already in the Set		The synchronized storage already exists in the set and cannot be added.
9	StorageSynchronized incompatible with Set		The synchronized storage is not compatible with the Set. For example, a FlashCopy is synchronized to a Sync Copy set.
0x1000	Parameters checked – Job started		The CLI copy command was run and a job object was returned.
0x1000	LogicalDevices associated to other ProtocolControllers not deleted	DeleteProtocolController()	At least one of the attached storage volumes is attached to another controller so it cannot be deleted.
0x1000	LogicalDevice instance not valid	AttachDevice()	The device is not a volume of the RedundancyGroup of the controller.
0x1000	LogicalDevice not associated to Controller	DetachDevice()	The device has no ProtocolControllerForUnit association to this controller.
0x1000	ID already created	CreateStorageHardwareID()	The WWPN is already assigned to an existing storage hardware ID.
0x1000	Specified instance not found	DeleteStorageHardwareID()	The storage hardware ID could not be found.
0x1000	HardwareID instance not valid	CreateGatewayID() AddHardwareIDsToCollection()	The storage hardware ID could not be found or is already a member of another collection.

Table 6. Common Information Model return codes (continued)

CIM return code	Description	Method	Explanation
0x1001	Size not supported	CreateOrModifyElementFromStoragePool()	The requested size is not supported by the primordial pools. The size parameter contains the nearest supported size larger than the requested one. The size requested was not a multiple of 512. The nearest supported size that can be requested is returned in size.
0x1001	Device Number Conflict	AttachDevice()	The specified device number is already occupied.
0x1001	Hardware implementation does not support specified IDType	CreateStorageHardwareID()	The type of ID is different from 2.
0x8000	ComputerSystem not valid	AddNode()	The submitted ComputerSystem was not a IBMTSSVC_CandidateNode.
		EvictNode()	The submitted ComputerSystem was not a IBMTSSVC_Node.
		Shutdown()	The submitted ComputerSystem was not a IBMTSSVC_Node of IBMTSSVC_Cluster.
0x8000	Locale not valid	SetLocale()	The submitted Locale was greater than 9.
0x8000	Type not valid	Dump()	A type greater than 2 was passed in.
0x8000	Connection refused	GetDump()	A connection was lost to the clustered system or failed to connect to a node (CISCO only).
0x8000	Backup not found	RestoreConfiguration()	The specified backup was not found.
0x8000	Delete failed	DeleteConfigurationBackup()	The deletion of the backup directory failed. The failure might have been caused by a sharing violation.
0x8000	IOGroup must have Nodes aggregated	SetIOGroup()	The I/O group does not have any nodes.
0x8000	ID not valid	SetQuorum()	The quorum ID is a number greater than 2.
0x8000	Volume not valid	IncludeBackendVolume()	The volume is not expelled.
0x8000	CopyType not supported	AttachReplica()	The type of copy passed in was different from 2 or 3.
		CreateReplica()	The type of copy passed in was different from 3 or 4.

Table 6. Common Information Model return codes (continued)

CIM return code	Description	Method	Explanation
0x8000	Ports are from multiple IOGroups	CreateProtocolControllerWithPorts()	All ports are required to belong to the same I/O group.
0x8000	HardwareID still bound to AuthorizationSubject. Force required	DeleteStorageHardwareID()	The hardware ID has access granted to a storage volume and Force was not specified.
0x8000	Host is member of a LUN mapping	DeleteHardwareIDCollection()	To delete this host either use this host to run the RemoveAccess method for each privilege and controller this host is associated to or set "Force" equal to "True."
0x8000	Record(s) not found	GetRecord() GetAllRecords()	No records were found.
0x8000	Cannot connect to clustered system	Create2062Cluster() Add2062Cluster()	Unable to connect to the clustered system.
0x8000	Connection to clustered system refused	Add2145Cluster()	The connection to the clustered system was refused.
0x8000	Connection to switch refused	Reset2062Node() Reload2062Node()	The connection to the switch was refused.
0x8000	Management IP not found	RemoveCluster()	The IP for the clustered system cannot be found.
0x8001	Maximum number of nodes for clustered system exceeded	AddNode()	All I/O groups already have two nodes assigned to them.
0x8001	Prefix not valid	Dump()	A file prefix and feature log type were passed in at the same time.
0x8001	File not found	GetDump()	The given file path was not found (CISCO).
0x8001	Backup script failed	BackupConfiguration()	The backup script returned with an error.
0x8001	Restore script failed	RestoreConfiguration()	The backup script returned with an error.
0x8001	Operation not supported for current state	ModifyConfiguration()	The operation submitted is not supported in the current state of the synchronized storage. For example, you cannot have a "prepare" operation on a synchronized storage in "synchronized" state.
0x8001	Operation not supported for current SyncState	ModifySynchronizedSet()	The operation is not supported with the current SyncState of the set.

Table 6. Common Information Model return codes (continued)

CIM return code	Description	Method	Explanation
0x8001	Unsupported protocol	CreateProtocol ControllerWith Ports()	Protocol != 2.
0x8001	Syntax error in ClusterName	Create2062 Cluster() Add2062Cluster() Reset2062Node() Reload2062Node()	The clustered system name is not valid because of a syntax error.
0x8002	ExtraCapacitySet not valid	AddNode()	The submitted ExtraCapacitySet was not a IBMTSSVC_ IOGroupSet.
0x8002	Secure copy failed	Backup Configuration()	The download of the backup file using secure copy failed.
0x8002	Secure copy failed	Upload Configuration()	The upload of the backup file using secure copy failed.
		CreateStorage HardwareID()	The name of the element and setting are required to be null.
0x8002	Syntax error in Node or Node is not valid	Create2062 Cluster() Add2062Cluster() Reset2062Node() Reload2062 Node()	The node contains a syntax error, or the specified node is not valid.
0x8003	Maximum number of Nodes for IOGroup exceeded	AddNode()	The submitted I/O group set already has two nodes assigned to it.
0x8003	Creation of backup dir failed	Backup Configuration()	The backup directory cannot be created.
0x8003	Clear command failed	Upload Configuration()	The clustered system /tmp/ directory cannot be cleared.
0x8003	Username or password not valid (only ResetNode)	Add2062Cluster() Reset2062Node() Reload2062Node()	The user name or password are not valid.
0x8004	Delete/rename of old backup files failed	N/A	The backup directory cannot be renamed or deleted.
0x8004	Wrong SwitchIP / cant connect to switch	Create2062 Cluster() Add2062Cluster()	The IP for the switch is not correct, so a connection to the switch cannot be made.
0x8004	SwitchIP is not configured	Reset2062Node() Reload2062Node()	The IP for the switch is not configured.
0x8005	Syntax error in IP of clustered system	N/A	The IP for the clustered system contains a syntax error.
0x8006	Slot not valid	N/A	The slot is not valid.
0x8007	Cannot upload public key to switch	N/A	The public key cannot be uploaded to the switch.

Table 6. Common Information Model return codes (continued)

CIM return code	Description	Method	Explanation
0x8100	Clustered system scope violation	N/A	One or more parameters were out of the clustered system scope.
0x8200	N/A	N/A	The method was run successfully but one or more parameters were ignored.

Appendix. Accessibility

Accessibility features help a user who has a physical disability, such as restricted mobility or limited vision, to use software products successfully.

Features

This list includes the major accessibility features in the management GUI:

- You can use screen-reader software and a digital speech synthesizer to hear what is displayed on the screen. The following screen reader has been tested: JAWS 11.
- Most of the GUI features are accessible by using the keyboard. For those features that are not accessible, equivalent function is available by using the command-line interface (CLI).

Navigating by keyboard

You can use keys or key combinations to perform operations and initiate many menu actions that can also be done through mouse actions. You can navigate the management GUI and help system from the keyboard by using the following key combinations:

- To navigate between different GUI panels, select the Low-graphics mode option on the GUI login panel. You can use this option to navigate to all the panels without manually typing the web addresses.
- To go to the next frame, press Ctrl+Tab.
- To move to the previous frame, press Shift+Ctrl+Tab.
- To navigate to the next link, button, or topic within a panel, press Tab inside a frame (page).
- To move to the previous link, button, or topic within a panel, press Shift+Tab.
- To select GUI objects, press Enter.
- To print the current page or active frame, press Ctrl+P.
- To expand a tree node, press the Right Arrow key. To collapse a tree node, press the Left Arrow key.
- To scroll all the way up, press Home; to scroll all the way down, press End.
- To go back, press Alt+Left Arrow key.
- To go forward, press Alt+Right Arrow key.
- For actions menus:
 - Press Tab to navigate to the grid header.
 - Press the Left or Right Arrow keys to reach the drop-down field.
 - Press Enter to open the drop-down menu.
 - Press the Up or Down Arrow keys to select the menu items.
 - Press Enter to launch the action.
- For filter panes:
 - Press Tab to navigate to the filter panes.
 - Press the Up or Down Arrow keys to change the filter or navigation for nonselection.

- Press Tab to navigate to the magnifying glass icon in the filter pane and press Enter.
- Type the filter text.
- Press Tab to navigate to the red X icon and press Enter to reset the filter.
- For information areas:
 - Press Tab to navigate to information areas.
 - Press Tab to navigate to the fields that are available for editing.
 - Type your edit and press Enter to issue the change command.

Accessing the publications

You can find the HTML version of the IBM Storwize V7000 information at the following website:

publib.boulder.ibm.com/infocenter/storwize/ic/index.jsp

You can access this information using screen-reader software and a digital speech synthesizer to hear what is displayed on the screen. The information was tested using the following screen reader: JAWS Version 10 or later.

Notices

This information was developed for products and services offered in the U.S.A.

IBM may not offer the products, services, or features discussed in this document in other countries. Consult your local IBM representative for information on the products and services currently available in your area. Any reference to an IBM product, program, or service is not intended to state or imply that only that IBM product, program, or service may be used. Any functionally equivalent product, program, or service that does not infringe any IBM intellectual property right may be used instead. However, it is the user's responsibility to evaluate and verify the operation of any non-IBM product, program, or service.

IBM may have patents or pending patent applications covering subject matter described in this document. The furnishing of this document does not give you any license to these patents. You can send license inquiries, in writing, to:

*IBM Director of Licensing
IBM Corporation
North Castle Drive
Armonk, NY 10504-1785
U.S.A.*

For license inquiries regarding double-byte (DBCS) information, contact the IBM Intellectual Property Department in your country or send inquiries, in writing, to:

*Intellectual Property Licensing
Legal and Intellectual Property Law
IBM Japan, Ltd.
1623-14, Shimotsuruma, Yamato-shi
Kanagawa 242-8502 Japan*

The following paragraph does not apply to the United Kingdom or any other country where such provisions are inconsistent with local law:

INTERNATIONAL BUSINESS MACHINES CORPORATION PROVIDES THIS PUBLICATION "AS IS" WITHOUT WARRANTY OF ANY KIND, EITHER EXPRESS OR IMPLIED, INCLUDING, BUT NOT LIMITED TO, THE IMPLIED WARRANTIES OF NON-INFRINGEMENT, MERCHANTABILITY OR FITNESS FOR A PARTICULAR PURPOSE. Some states do not allow disclaimer of express or implied warranties in certain transactions, therefore, this statement may not apply to you.

This information could include technical inaccuracies or typographical errors. Changes are periodically made to the information herein; these changes will be incorporated in new editions of the publication. IBM may make improvements and/or changes in the product(s) and/or the program(s) described in this publication at any time without notice.

Any references in this information to non-IBM websites are provided for convenience only and do not in any manner serve as an endorsement of those websites. The materials at those websites are not part of the materials for this IBM product and use of those websites is at your own risk.

IBM may use or distribute any of the information you supply in any way it believes appropriate without incurring any obligation to you.

Licensees of this program who wish to have information about it for the purpose of enabling: (i) the exchange of information between independently created programs and other programs (including this one) and (ii) the mutual use of the information which has been exchanged, should contact:

*IBM Corporation
Almaden Research
650 Harry Road
Bldg 80, D3-304, Department 277
San Jose, CA 95120-6099
U.S.A.*

Such information may be available, subject to appropriate terms and conditions, including in some cases, payment of a fee.

The licensed program described in this document and all licensed material available for it are provided by IBM under terms of the IBM Customer Agreement, IBM International Program License Agreement or any equivalent agreement between us.

Any performance data contained herein was determined in a controlled environment. Therefore, the results obtained in other operating environments may vary significantly. Some measurements may have been made on development-level systems and there is no guarantee that these measurements will be the same on generally available systems. Furthermore, some measurement may have been estimated through extrapolation. Actual results may vary. Users of this document should verify the applicable data for their specific environment.

Information concerning non-IBM products was obtained from the suppliers of those products, their published announcements or other publicly available sources. IBM has not tested those products and cannot confirm the accuracy of performance, compatibility or any other claims related to non-IBM products. Questions on the capabilities of non-IBM products may be addressed to the suppliers of those products.

All statements regarding IBM's future direction or intent are subject to change or withdrawal without notice, and represent goals and objectives only.

This information is for planning purposes only. The information herein is subject to change before the products described become available.

This information contains examples of data and reports used in daily business operations. To illustrate them as completely as possible, the examples include the names of individuals, companies, brands, and products. All of these names are fictitious and any similarity to the names and addresses used by an actual business enterprise is entirely coincidental.

COPYRIGHT LICENSE:

This information contains sample application programs in source language, which illustrate programming techniques on various operating platforms. You may copy, modify, and distribute these sample programs in any form without payment to IBM, for the purposes of developing, using, marketing or distributing application

programs conforming to the application programming interface for the operating platform for which the sample programs are written. These examples have not been thoroughly tested under all conditions. IBM, therefore, cannot guarantee or imply reliability, serviceability, or function of these programs. The sample programs are provided "AS IS", without warranty of any kind. IBM shall not be liable for any damages arising out of your use of the sample programs.

If you are viewing this information softcopy, the photographs and color illustrations may not appear.

Trademarks

IBM, the IBM logo, and ibm.com are trademarks or registered trademarks of International Business Machines Corp., registered in many jurisdictions worldwide. Other product and service names might be trademarks of IBM or other companies. A current list of IBM trademarks is available on the web at Copyright and trademark information at www.ibm.com/legal/copytrade.shtml.

Adobe and the Adobe logo are either registered trademarks or trademarks of Adobe Systems Incorporated in the United States, and/or other countries.

Intel, Intel logo, Intel Xeon, and Pentium are trademarks or registered trademarks of Intel Corporation or its subsidiaries in the United States and other countries.

Linux is a registered trademark of Linus Torvalds in the United States, other countries, or both.

Microsoft, Windows, Windows NT, and the Windows logo are trademarks of Microsoft Corporation in the United States, other countries, or both.

UNIX is a registered trademark of The Open Group in the United States and other countries.

Java and all Java-based trademarks and logos are trademarks or registered trademarks of Oracle and/or its affiliates.

Other product and service names might be trademarks of IBM or other companies.

Index

A

- about this document
 - sending comments xiii
- access point subprofile 9
- accessibility
 - keyboard 65
 - repeat rate
 - up and down buttons 65
 - shortcut keys 65
- accessing
 - publications 65
- agent code, defined 3
- Aperi 6
- architectural diagrams 9
- argument generators class 39
- array creation
 - RAID 33
- association, defined 2

B

- block server performance subprofile 9
- block services profile 11

C

- CIM client frameworks 6
- CIM object manager (CIMOM),
 - defined 3
- CIMOM programming 6
- class, defined 2
- classes
 - list of 47
 - supported 51
- client application, defined 3
- clustered system
 - creating synchronous relationship
 - between volumes in different clustered system 38
 - creating synchronous relationship
 - between volumes in same clustered system 37
 - mapping 39
 - subprofile 13
- comments, sending xiii
- Common Information Model (CIM),
 - defined 1
- concepts 7
 - CIM agent 2
 - comparing CIM and Storwize V7000 7
 - defined 2
- configuration
 - creating a RAID array 33
 - creating a storage pool 31
 - creating a storage volume 32
 - modifying a storage pool 32
- connection data, setting manually 45

copy services

- creating a FlashCopy between storage volumes 35
- creating a FlashCopy for synchronized set 36
- creating synchronous relationship
 - between volumes in different clustered system 38
- creating synchronous relationship
 - between volumes in same clustered system 37
- diagram 14
- FlashCopy (instant) 35
- Global Mirror (asynchronous) 35
- Metro Mirror (synchronous) 35
- relationships 35

D

- device provider, defined 3
- device, defined 3
- diagnostic tasks 47
 - collecting log files 49
- diagrams 9
 - access point subprofile 9
 - block server performance subprofile 9
 - block services profile 11
 - CIMOM on the clustered system 4
 - clustered system subprofile 13
 - copy services 14
 - disk drive lite profile 15
 - disk-drive failure association 17
 - disk-drive sparing CIM structure 16
 - enclosure profile 18
 - extent composition subprofile 18
 - FC port profile 19
 - interop profile 20
 - iSCSI relationships 21
 - IsSpare association 17
 - job control profile 23
 - location subprofile 23
 - masking and mapping profile 24
 - multiple computer system profile 25
 - object manager adapter profile 26
 - physical package overview 27
 - RAID support 13
 - server profile 27
 - software profile 28
 - storage volume mirroring 29
 - typical CIM agent at work 4
- disk drive
 - failure association 17
 - spare extents 17
 - sparing 16
 - sparing CIM structure 16
- disk drive lite profile 15
- DiskDriveExtent failure 17
- documentation
 - improvement xiii

E

- enclosure
 - classes list 47
 - installed units, number of 48
 - profile 18
 - unit types list 47
- error codes 53
- examples
 - typical configuration 4
- extent composition subprofile 18

F

- FC port profile 19
- FC port statistics 48
- FlashCopy
 - about 35
 - creating between storage volumes 35
 - creating for synchronized set 36
 - sample code
 - argument generators class 39
 - getCluster method 39
 - getConfigService method 39
 - getFCMappings method 39
 - getVolumes method 39
 - Java main method 39
 - makeFlashCopyMapping method 39
 - prepareFCMapping method 39
 - startFCMapping method 39
- functional diagrams 9
 - access point subprofile 9
 - block server performance subprofile 9
 - block services profile 11
 - clustered system subprofile 13
 - copy services 14
 - disk drive lite profile 15
 - disk-drive failure association 17
 - disk-drive sparing CIM structure 16
 - enclosure profile 18
 - extent composition subprofile 18
 - FC port profile 19
 - interop profile 20
 - iSCSI relationships 21
 - IsSpare association 17
 - job control profile 23
 - location subprofile 23
 - masking and mapping profile 24
 - multiple computer system profile 25
 - object manager adapter profile 26
 - physical package overview 27
 - RAID support 13
 - server profile 27
 - software profile 28
 - storage volume mirroring 29

G

getCluster method 39
getConfigService method 39
getFCMappings method 39
getVolumes method 39
Global Mirror (asynchronous) 35

I

indication service 26, 48
indication, defined 2
information
 center x
installed units, number of 48
instance, defined 2
interop profile 20
introduction 1
iSCSI relationships diagram 21
IsSpare association 17

J

Java main method 39
Java WBEM Service project 6
job control profile 23

K

keyboard
 accessibility 65

L

legal notices
 Notices 67
 trademarks 69
location subprofile 23
log files 49

M

main components 3
maintenance tasks 47
makeFlashCopyMapping method 39
Managed Object Format (MOF)
 documentation 6, 51
Managed Object Format (MOF),
 defined 2
mapping 7
 CIM concepts to Storwize V7000
 concepts 7
 sample code, FlashCopy
 argument generators class 39
 getCluster method 39
 getConfigService method 39
 getFCMappings method 39
 getVolumes method 39
 Java main method 39
 makeFlashCopyMapping
 method 39
 prepareFCMapping method 39
 startFCMapping method 39
masking and mapping profile 24
method, defined 2

methods, supported 51
Metro Mirror (synchronous) 35
multiple computer system profile 25

N

namespace, defined 2
network considerations 45

O

object manager adapter profile 26
object path, defined 2
overview 2, 3

P

performance statistics 48
physical package overview diagram 27
prepareFCMapping method 39
profiles and subprofiles
 access point subprofile 9
 block server performance
 subprofile 9
 block services profile 11
 clustered system subprofile 13
 copy services 14
 disk drive lite profile 15
 enclosure profile 18
 extent composition subprofile 18
 FC port profile 19
 interop profile 20
 job control profile 23
 location subprofile 23
 masking and mapping profile 24
 multiple computer system profile 25
 object manager adapter profile 26
 RAID support 13
 server profile 27
 SMI-S, supported 51
 software profile 28
property, defined 2
publications
 accessing 65

Q

qualifier, defined 2

R

RAID
 array creation 33
 support diagram 13
reader feedback, sending xiii
reference, defined 2
related information x
remote connection access 45
RemoteServiceAccessPoint (RSAP)
 instance 45
return codes 53

S

SBLIM CIM Client for Java 6
schema, defined 2
Secure Sockets Layer (SSL) 45
sending
 comments xiii
server profile 27
Service Location Protocol (SLP) 4
 defined 1, 3
services
 FlashCopy (instant) 35
 Global Mirror (asynchronous) 35
 Metro Mirror (synchronous) 35
setting connection data manually 45
shortcut keys
 accessibility 65
 keyboard 65
SMI-S 1
SMI-S profiles 51
software profile 28
startFCMapping method 39
statistics, performance 48
storage configuration tasks 31
Storage Management Initiative
 Specification (SMI-S) 1
 supported profiles 51
storage pool
 creating 31
 modifying 32
storage volume
 creating 32
 creating a FlashCopy 35
 creating a FlashCopy for synchronized
 set 36
 creating synchronous relationship
 between volumes in different
 clustered system 38
 creating synchronous relationship
 between volumes in same clustered
 system 37
 parameters 32
storage volume mirroring diagram 29
Storwize V7000 library
 related publications x
subprofile
 access point 9
 block server performance 9
 clustered system 13
 extent composition 18
 location 23

T

tasks, storage configuration 31
trademarks 69

U

unit types, list of 47

W

Web-Based Enterprise Management
(WBEM), defined 1



Printed in USA

GC27-2292-02

